



**EN**

**IST-1408.CE02.02/A**

File: IST-1408.CE02.02-A\_CE408-EN (04.03.2021).docx

**GAS CONTROL UNIT**

**CITY**

**CE408P**

**Max no.8 4÷20mA Gas Detectors**

**USER MANUAL**

**TECNOCENTROL S.r.l.**

Via Miglioli, 47 20054 SEGRATE (MI) Italy- Tel. (+39) 02 26922890 - Fax (+39)02 2133734

http: [www.cpftecnogeca.com](http://www.cpftecnogeca.com) e-mail: [info@tecnocentrol.it](mailto:info@tecnocentrol.it)



## Please read and keep care of this manual and the manual of installed sensors too.

All documentation relating to gas detection plant should be preserved, because it contains the procedures to be used during the routines verification and / or during the periodic calibration. We recommend that you always complete the [Setup Memorandum Tables in the last pages of this manual](#). This will facilitate any possible change to the configuration and/or in case of additional sensors, and operations and maintenance service.

### INFORMATION AND WARNINGS OF USE

The control unit is suitable for gas alarm systems up to **No.8 detection points**. The simple installation and easy configuration via the buttons make the unit suitable for use in many areas, both civil and industrial.

It should be noted that inappropriate use or lack of maintenance can affect the operation of the device and thus preventing the proper activation of alarms with potential serious consequences for the user.



TECNOCONTROL disclaims any responsibility if the product is misused, altered or not as planned or outside the rated operating limits or put in work incorrectly. The choice and use of the product are the sole responsibility of the individual operator.

The rules, laws, etc. mentioned, are the ones valid on the date of issue. In any case, must be observed all applicable national regulations in the country of use.

The information contained in this document are accurate, current at the date of publication, and are the result of continuous research and development, the specifications of this product and what is indicated in this manual may be changed without notice.



The Control Unit has a clock with the automatic DST change (Setting for Italy on UTC + 01:00 Time Zone). In the absence of power supply, the clock works with the lithium battery (on the board in the cover), its life, in normal operation is over 5 years.

If the lithium battery is exhausted and the Control Unit remained completely without power, at start up, you will need to enter the correct date and time ([see chapter Date and Time](#)) and then the battery must be replaced soon with a new one.

### NOTES FOR READING INSTRUCTION

**CE408** Control unit up to **No.8 gas detectors**. It has 4 detectors inputs installed, expandable up to 8 with no.1 ES404 card. Equipped with No.5 relay outputs expandable to 9 with no.1 ES414 card. The control unit also has No.1 Logic Input.

**ES404** Expansion card with No.4 inputs

**ES414** Expansion card with No.4 relay outputs.

**SENSOR** It is the name that, for simplicity, is indicated the Remote Gas Detectors models.

**FIRMWARE** Program inserted into the microcontroller which controls the unit functioning.



Symbol that indicates an important warning in the instructions.



Symbol indicates information or additional explanation in the instructions.

<b>Documento / Document:</b> IST-1408.CE02.02-A_CE408-EN (04.03.2021).docx			
<b>Oggetto / Subject / Objet:</b> CE408 (4÷20mA) Centrale da parete / Wall mount Control Unit / Centrale de contrôle murale (GIUGIARO design).			
<b>Cronologia delle revisioni / Revision History / Historique des révisions</b>			
Rev.	Data / Date	Da / By	Note
0	25/11/2016	UT/FG	1° Emissione / 1 <sup>st</sup> Edition / 1 <sup>ere</sup> délivré
A	04/03/2021	UT/FG	Aggiornamento Documento per Firmware Vers.2.0 / Document Update for Firmware Vers.2.0 / Mise à jour du document pour le micrologiciel version 2.0

## SOMMARIO

<b>INFORMATION AND WARNINGS OF USE</b>	<b>2</b>
<b>NOTES FOR READING INSTRUCTION</b>	<b>2</b>
<b>PRODUCT DESCRIPTION</b>	<b>5</b>
Fig.1 – CE408 - Wall mount housing	5
Fig.2 - Eg installation with TS282 series detectors.	6
<b>CONTROL UNIT INSTALLATION</b>	<b>8</b>
Fig 3 – Dimensions and Template for wall mounting.	8
<b>OPEN – CLOSING THE HOUSING</b>	<b>8</b>
<b>ELECTRICAL CONNECTIONS</b>	<b>9</b>
Fig.4 – Inputs for cable glands	9
<b>Power connection</b>	<b>10</b>
Fig 5 – CE408P Wiring diagram for Power, Batteries, AUX input and relay output No.9.	10
<b>Connection with Gas Detectors (Sensors)</b>	<b>11</b>
Fig 6 – Wiring diagram for Inputs Sensor 4 to 20mA and relay Outputs NA=NO	11 11
<b>USE OF THE CONTROL UNIT</b>	<b>13</b>
Fig.7 – CE408P Keyboard	13
• Keyboard	13
• LEDs indications	13
• Internal Buzzer indication	13
• Single digit numeric field (password entry, etc.)	13
• Screens 'Enable ...', 'Disable ...', 'Copy ...', 'Delete ...', 'Settings-> Date & Time':	14
• Display – All other Screens:	14
• Display – Initial Screens	14
• Preheating Time	14
• Display – Main Screen	14
<b>MAIN MENU</b>	<b>17</b>
• List and short description of the accessible menus and the required ① or ② Password:	17
<b>RESET</b>	<b>18</b>
<b>SENSORS</b>	<b>18</b>
SENSORS-ENABLE / DISABLE (Level 1):	18
CONFIGURE SENSORS (Level 2):	19
• CONFIGURE - PRECONFIGURED SENSOR:	19
• Description of items related to the Preconfigured sensor:	20
• Description of the items relating to the outputs:	21
• CONFIGURE - GENERIC SENSOR:	22
• Description of the items relating to the GENERIC SENSORS:	22
SENSORS-COPY (Level 2):	23
SENSORS-DELETE (Level 2):	23
SENSORS-MODIFY (Level 2):	24
SENSORS-DETAILS:	24
<b>LOGIC INPUT</b>	<b>24</b>
LOGIC INPUT - ENABLE/DISABLE (Level 1):	24
LOGIC INPUT – CONFIGURE (Level 2):	24
LOGIC INPUT – DELETE (Level 2):	25
LOGIC INPUT - MODIFY (Level 2):	25
LOGIC INPUT – DETAILS:	25
<b>ZONES</b>	<b>25</b>
ZONES - ENABLE/DISABLE (Level 1):	25
ZONES - CONFIGURE (Level 2):	26
• Description of items related to the Zone:	26
• Description of the items relating to the outputs:	26

ZONES-DELETE (Level 2):	27
ZONES-MODIFY (Level 2):	27
ZONES-DETAILS:	27
<b>EVENTS</b>	<b>27</b>
EVENTS - ALARMS / FAULTS	27
EVENTS - ALL	27
<b>SETTINGS</b>	<b>28</b>
SETTINGS-LANGUAGE (Level 1):	28
SETTINGS-DISPLAY CONTRAST	29
SETTINGS-BUZZER (Level 1)	29
• ALARMS	29
• FAULTS	29
SETTINGS-DATE and TIME (Level 1):	29
SETTINGS-INFO	29
<b>PASSWORD</b>	<b>29</b>
ENABLE LEVEL:	30
DISABLE LEVEL	30
CHANGE PASSWORD:	30
<b>SERVICE</b>	<b>31</b>
SERVICE-ELECTRIC TEST (Level 2):	31
SERVICE-BATTERY (Level 2):	32
SERVICE SENSORS STATUS (Level 2):	32
SERVICE-FACTORY TEST (Level 3)	32
<b>SD CARD</b>	<b>32</b>
UPDATE FW. (Level 2):	33
Fig.12-SD-Card insertion	33
<b>APPENDIX</b>	<b>34</b>
<b>TECHNICAL SPECIFICATIONS</b>	<b>34</b>
<i>Summary of the list of Fault and Alarm messages</i>	<b>35</b>
<b>TABLES with List of PRECONFIGURED Gas Detectors</b>	<b>36</b>
<b>TABLE 1 – Models with 4÷20mA output and Replaceable Sensor Cartridge.</b>	<b>36</b>
<b>TABLE 2 - Models with DISPLAY and Replaceable Sensor Cartridge</b>	<b>37</b>
<b>TABLE 3 - Models with Fixed Sensor (Parking, Heating Plants, Civil installations)</b>	<b>38</b>
<b>TABLE 4 - Models and Values of TLVs</b>	<b>38</b>
<b>TABLE 5A-Pre-configured values for PARKING-EN (EN50545-1)</b>	<b>38</b>
<b>TABLE 5B – USED ONLY IN ITALY - Values to be set to use with PARKING-ITA</b>	<b>39</b>
<b>TABLE 6 - PRECONFIGURED Parameters of Relay Output Operation</b>	<b>39</b>
<b>Configuration Reminder Tables</b>	<b>40</b>
<b>EN Diagram Menu with access without password</b>	<b>43</b>

## PRODUCT DESCRIPTION

Fig.1 – CE408 - Wall mount housing

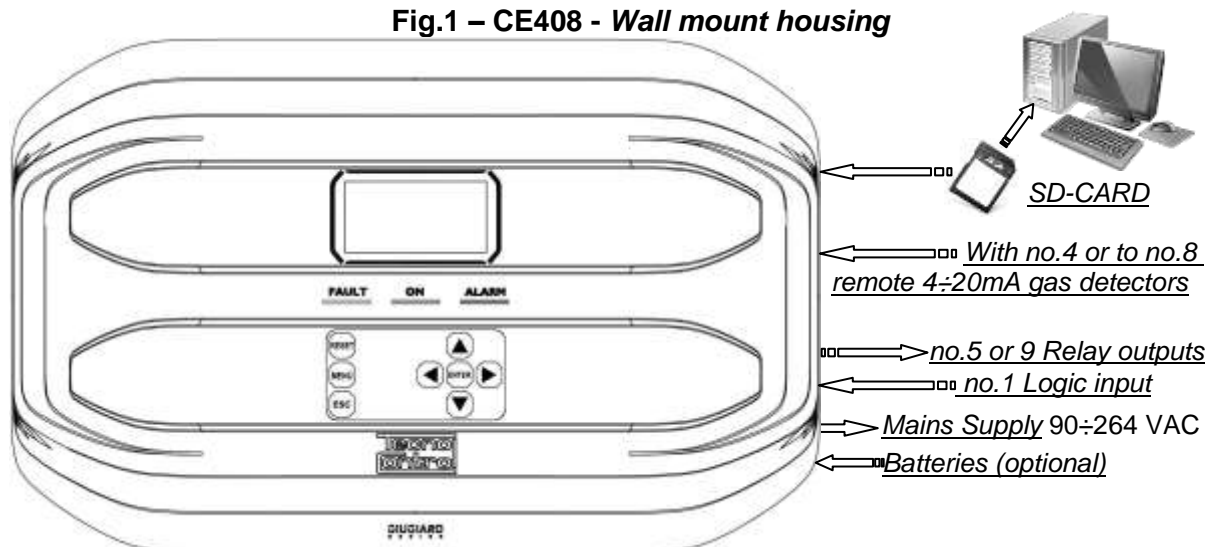

- **The Control unit is wall mount, GIUGIARO DESIGN housing 379x241x133 mm.**
- **The CE408P can be connected up to no.8 of our remote Gas Detectors (Sensors) with three-wire, 4÷20mA linear output: (See List in Table 1)**

Models with “Replaceable Cartridge Sensor” for:

- Flammable gases with Catalytic sensor (20% LEL range) TS282K(IP65) or TS293K(Ex”d”) series.*
- Flammable gases with Pellistor sensor (100% LEL range) TS282P(IP65) or TS293P (Ex”d”) series.*
- Flammable gases with Infrared sensor (100% LEL range) TS293I(Ex”d”) series.*
- Toxic gases with electrochemical cell TS282E (IP65) or TS293E (Ex”d”) series.*
- Oxygen with electrochemical cell (25% volume range) TS282EO or TS293EO (Ex”d”).*
- Carbon dioxide with Infrared sensor TS210IC2 (IP54), TS282IC2 (IP65) or TS293IC2 (Ex”d”).*
- Parking with dual sensor TS255CB (CO+PETROL vapors) or TS255CN2 (CO+NO<sub>2</sub>)*
- Refrigerant gases with Semiconductor sensor TS282SF (IP65) or TS293SF (Ex”d”) series.*

Models with Display and with “Replaceable Cartridge Sensor” for:

- Flammable gases with Pellistor sensor (100% LFL range) TS593P (Ex ”d”) series.*
- Flammable gases with Infrared sensor (100% LEL range) TS593I (Ex”d”) series.*
- Toxic gases with electrochemical cell TS293E (Ex”d”) series.*
- Oxygen with electrochemical cell (25% volume range) TS593EO (Ex”d”).*

Should be connecting all models without the replaceable Cartridge:

- Refrigerant gases with Infrared sensor TS282IF (IP42) series.*

Models without replaceable cartridge, usable only in non-industrial environments, for

- Flammable gases with Catalytic sensor (20% LEL range) SE192K (IP44) or SE193K (Ex”d”) series.*
- Toxic gases with electrochemical cell (300ppm CO range) TS192EC(IP44) or SE193EC(Ex”d”) series*

**May be connected, even discontinued models.** Detectors three-wire 4 to 20mA linear for flammable gases or those two-wire 4 to 20mA linear for toxic gases or oxygen, produced until December 2008. Also, from January 2017 the TS282xx (IP65) series, supersede all TS220xx and the TS292xx.(Example: TS292KM will become TS282KM or the TS220EO will become TS282EO).



Inputs are configurable for 4÷20mA sensors with referred current to ground and operating characteristics same as our products (unit in %LEL or ppm, minimum operating voltage, absorption, load resistance etc.).



**Available gas detectors: some models of detectors or calibrations for some gases may not yet be available. We recommend that you contact us for confirmation or for specific requests. e-mail: [info@tecnocontrol.it](mailto:info@tecnocontrol.it)**



**NO LIABILITY IS DISCLAIMED FOR MALFUNCTIONS, FAILURES OR DAMAGES CAUSED BY PRODUCTS THAT ARE NOT COMPATIBLE OR NOT OF OUR PRODUCTION.**

- **The Unit has No.1 AUX input, which can be associated with a relay output:**

It can be configured to activate one of the available relays and can be used by devices with **NO** or **NC** contact outputs (gas sensors with a relay contact, smoke sensors, buttons, etc.).

- **Each Sensor can be configured in two ways quickly and easily:**

**Preconfigured Setup:** Here you can choose one of the models of our production, ([See list in Table 1](#)), which is then automatically set in the configuration recommended by the respective thresholds and relay outputs. **Is enough set the output number (relay) to complete the configuration.** Modifications of the other values are however allowed.

**Generic Configuration:** Here you can configure any type of sensor (*compatible or a new model not yet listed*), manually entering all parameters.

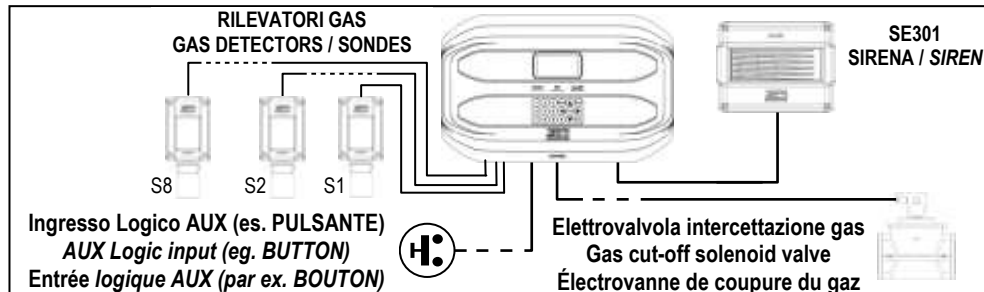

Fig.2 - Eg installation with TS282 series detectors.

- **Each Sensor is protected and has a FAULT signal:**

All sensors inputs are protected against short-circuit or wire breakings. If a short-circuit occurs, the power supply to that input, is automatically stopped (all others continue to work properly). At the same time, the FAULT signal is activated.

- **Each Sensor may be associated with a ZONE:**

The sensors can be grouped into **Zones (Max No.2)**, which can associate up to **No.2 relay** outputs different for each alarm level and **No.1 for the FAULT**.

- **Each ZONE can be set according to operating LOGIC:**

The logic used are the typical logic functions (**OR, AND**), management of adjacent sensors (**CORR.CON, CIRC.CON**). Note that **PARK-ITA** is a function only for Italy standard (Italian Ministerial Decree DM 01/02/1986 replaced by DM 08/03/2015 and subsequent updates).

- **The Unit can manage up to No.5, or No.9 Alarm relays:**

Each sensor has three alarm levels (**Threshold 1, Threshold 2 and Threshold 3**) and a **FAULT**, freely addressable to any relay output. The control unit has no.5 relay already installed, which can be increased to No.9 with the **expansion card ES414**.

- **The alarm thresholds can be configured with special mode of operation:**

For use in car parking "**PARKING EN**" (EN 50545-1) or to the workplace, such as exposure limit value **TLV**.

- **Each output (relay) can be configured as follows:**

- **Silenceable:** the output is disabled for the **Silence time**, when **RESET** is carried out and the sensor is above the set threshold. This function can, for example, be used for the outputs connected to audible warning devices.
- **Silence Time:** is the time, adjustable from 0 to 300 seconds, so **Silenceable output** (e.g. relay connected to a siren) is disabled when the **RESET** is performed and a sensor is above the set threshold
- **Hysteresis ON:** is the delay, adjustable from 0 to 300 seconds, of the relay, associated with an alarm threshold.
- **Hysteresis OFF:** is the delay, adjustable from 0 to 300 seconds, of the relay to return to normal condition, when it ends the alarm.
- **Time ON:** is adjustable from 0 to 300 seconds. This function can only be used if you want to stop the alarm output after a finite time, even if the sensor remains above the alarm threshold set (This function cannot be used in conjunction with Hysteresis OFF delay). For example you can use it to enable devices that cannot be powered down, or to send a pulse to a phone dialer.

- **Memorized**: the relay remains in alarm, even if the sensor returns below the threshold (*this function does not work if the **Time ON** or into **Hysteresis OFF** has already been inserted a value other than zero*), to return to normal conditions must be done **RESET**. Serves, for example, to prevent the accidental or unauthorized resetting of a block valve of the gas, without first checking the cause of the alarm.
- **Positive Logic**: the operation of the relay can be set normally activated or in positive logic, therefore, if the relay fails, or is completely out of power, automatically moves into the Alarm position, the NC contact becomes NO.

- **The Control Unit has a BUZZER inside:**

The internal **Buzzer** sounds a **Beep** every touch of the keyboard. It can also be set to sound in case of Fault and / or Alarm.

- **The Control Unit can store the Events:**

The system can store up to 100 events comprising Alarms, Faults, Power ON, Mains blackout and Resetting, that can be re-called at any time.

- **The Control Unit has an SD-CARD slot, it can be used for:**

Future updates of the Control Unit firmware.

- **The Control Unit is protected by 3 LEVELS of PASSWORD:**

Some menus are accessible up to three password levels, with a code composed of 4 numbers. The levels are for access to functions, used by the respective authorized persons:

**LEVEL 1:** for the User

**LEVEL 2:** for the Installer or Maintenance technician.

**LEVEL 3:** **Reserved** - Only accessible for factory settings.

## CONTROL UNIT INSTALLATION



**THE FOLLOWING INSTRUCTIONS DESCRIBES ALL THE CONTROL UNIT SYSTEM SETUP PROCEDURES AND THE INSTALLATION PROCEDURES TO BE EXECUTED ONLY BY AUTHORISED AND EXPERIENCED STAFF.**



**WARNING:** The unit is to be installed in an area protected from direct sunlight and rain. Please note that for safety the unit is to be installed in safe areas where there are present or can form flammable atmospheres and concentrations exceeding 24% volume of oxygen.

**CLEANING:** To clean the exterior of the enclosure, use a soft damp cloth with water; do not use solvents or abrasive cleaners.

**POSITIONING:** The unit should be mounted on the wall using 4 screws and wall plugs (Ø 6 mm) or 4 M4 screws and nuts, if the wall is not in masonry. The housing's base must be fixed through the 4 holes, on the sides of the base (Fig.3). The electrical connections should be executed all on the housing base.

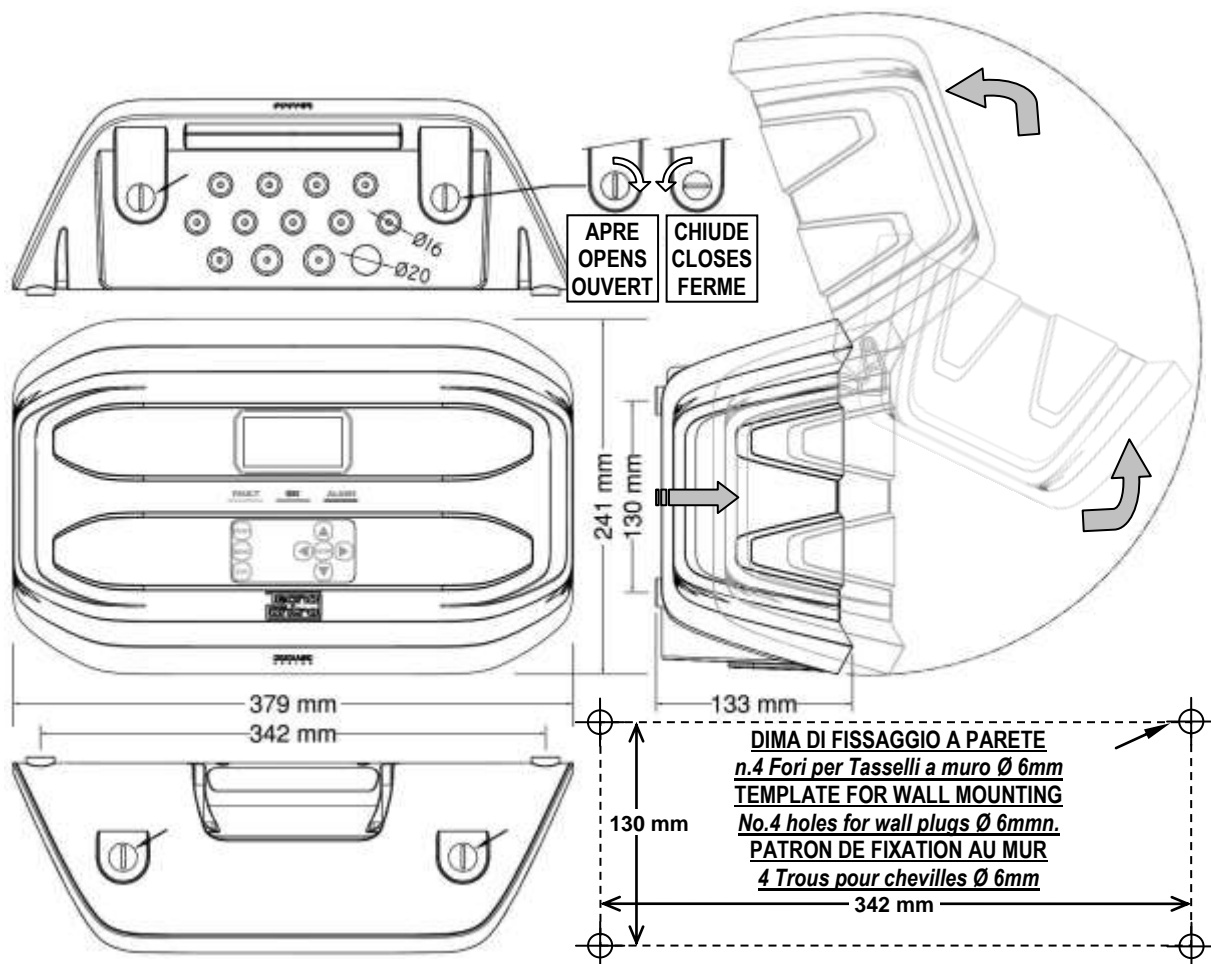

**Fig 3 – Dimensions and Template for wall mounting.**

The cover unlocks (with a coin) by turning 90° the 4 buttons located above and below the enclosure. It is opened by pulling and then rotating it up until it rests at the base.

### OPEN – CLOSING THE HOUSING

The housing has two sliding internal hinges. To open the case, you must:

- 1- With a coin or screwdriver (blade 10-12 mm), unlock the 4 closing buttons, turning them 90° clockwise.
- 2- Gently, pull the cover outwards of about 4 cm and then rotate it up and place it on the upper edge of the base housing, in this way remain in the open position.

To close the housing act in reverse order. Pay attention that the cover and the locking mechanism enter into place. Finally block 4 buttons, turning 90° counterclockwise. To facilitate the closure, press on the lid, the buttons, which are eccentric, will bring the lid to adhere to the base housing.



## ELECTRICAL CONNECTIONS

The electrical connections should be executed all on the housing base.



The details of the connections to the mains, the two batteries, the AUX input and relay output R9 are illustrated [in Figure 4](#). While the details of the connections to the sensors and the other outputs are illustrated [in Figure 5](#).



The terminals are of "polarized inlet" type (1). We suggest to use lugs adequate to the conductors (2) and to fix the wires to the box structure to avoid excessive stress to the circuits and to the terminals. Use a screwdriver (3) with the right dimensions.

Input terminal,  
plug-polarized.

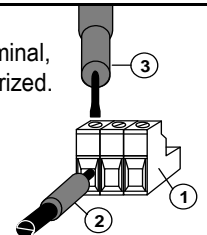

Considering that, it should be normal procedure disconnect power to the electronic equipment when installing, or changing the connections, or when disconnecting or connecting expansion cards.



**IMPORTANT: TO AVOID IRREVERSIBLE DAMAGE, DISCONNECT THE POWER SUPPLY TO THE CONTROL UNIT, MAINS POWER AND BATTERY (IF PRESENTS) DURING INSTALLATION (WIRING CABLES) OR BEFORE YOU INSTALL ANY EXPANSION BOARDS OR UNPLUG OR RE-CONNECT THE FLAT CABLE.**



Only if necessary, for maintenance or installation requirements, the housing cover can be separated from its base, first remove mains power and remove the batteries, then disconnect the flat cable, press on the two side tabs as shown in [Fig. 3](#). Then you need to release the cover from sliding hinges (press fit). To reconnect it, proceed in reverse order and after hanging up the lid hinges, push the flat cable into the connector, respecting the polarization, the two levers close automatically locking it. Only then you can reconnect power supply.

**BATTERIES:** Inside the housing, it can also accommodate **two 12V/1.3Ah Lead batteries** connected in series ([Fig.5](#)) to assure the system powering in case of mains blackout.

The battery life is about **20 minutes with No.8 sensors**, but each detector in less increases the autonomy of about **4 min**.



(The batteries are not included in the delivery, but are available on request). If required, to increase the autonomy, **No.2 12V, 3Ah or 7Ah batteries connected in series** can be used, but due to their size, they must be installed outside the control unit.

Considering that each detector absorbs **0.08A/h** from the battery, the autonomy, with **8 detectors**, becomes: about **4 hours with 3Ah** batteries (each sensor less increases the autonomy by about **30 min**) and about **8 hours with 7Ah** (each sensor less increases the autonomy of about **60 minutes**).

**CABLE GLANDS:** the lower side of the housing has 13 inputs designed for metric cable glands (ISO pitch 1.5 mm). No.10 are for glands M16x1.5 mm (that accept external cables  $\varnothing$  4÷8 mm) and n.3 are for glands M20x1.5 mm (that accept external cables  $\varnothing$  6÷12 mm).

These passages are closed, but they are not manually breakable, according to the installation requirements, they must be drilling. To facilitate the operation, they have a centering for the drill bit.

Please, pay attention not touch the tip of the internal circuits or the power supply cables

To guarantee the degree of protection of the enclosure, it is recommended to use cable glands with protection IP55 or higher.

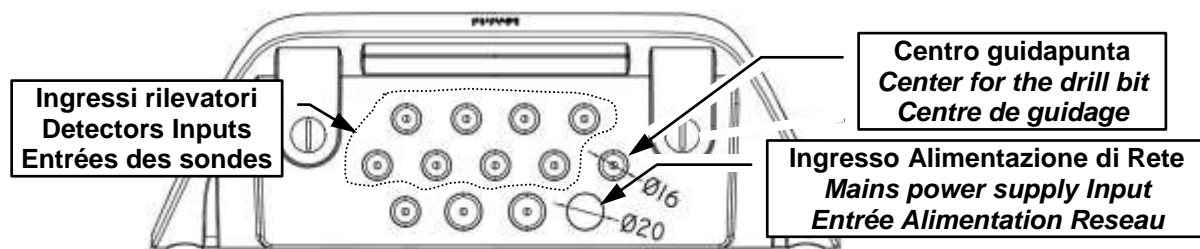

Fig.4 – Inputs for cable glands

## Power connection

The installation must include a power line protection device. To the mains line, a bipolar disconnecting switch dedicated for the gas detection system. The device, clearly identified, must act only on Phase and Neutral, but not on the Earth. It is advisable to also provide for a surge protector, lightning etc.

**Mains Power Supply** (90÷264Vdc / 47÷63Hz) should be connected to terminal **L**, **N** and **Earth** at the right of the housing base. The terminal has a protective fuse (5x20) 2A.

**The two 12V/1.3Ah Lead internal batteries** if required should be connected in series to **BAT+** (Red) and **BAT-** (Black) terminals. For the series connection, use the black cable supplied with two terminals (4.8 mm Fastens).

**The auxiliary input (AUX)** can be used to connect devices with a **NO** or **NC** contact (*gas sensors with relay contacts, smoke sensors, buttons, etc.*). It can be configured to activate one of the available relays. It can be connected to multiple devices if it's are homogeneous. (If the device has an NC contact must be connected in series or in parallel if it's have all a contact NO).

**Output Relay No.9** has the same characteristics and use of those described on the next page.

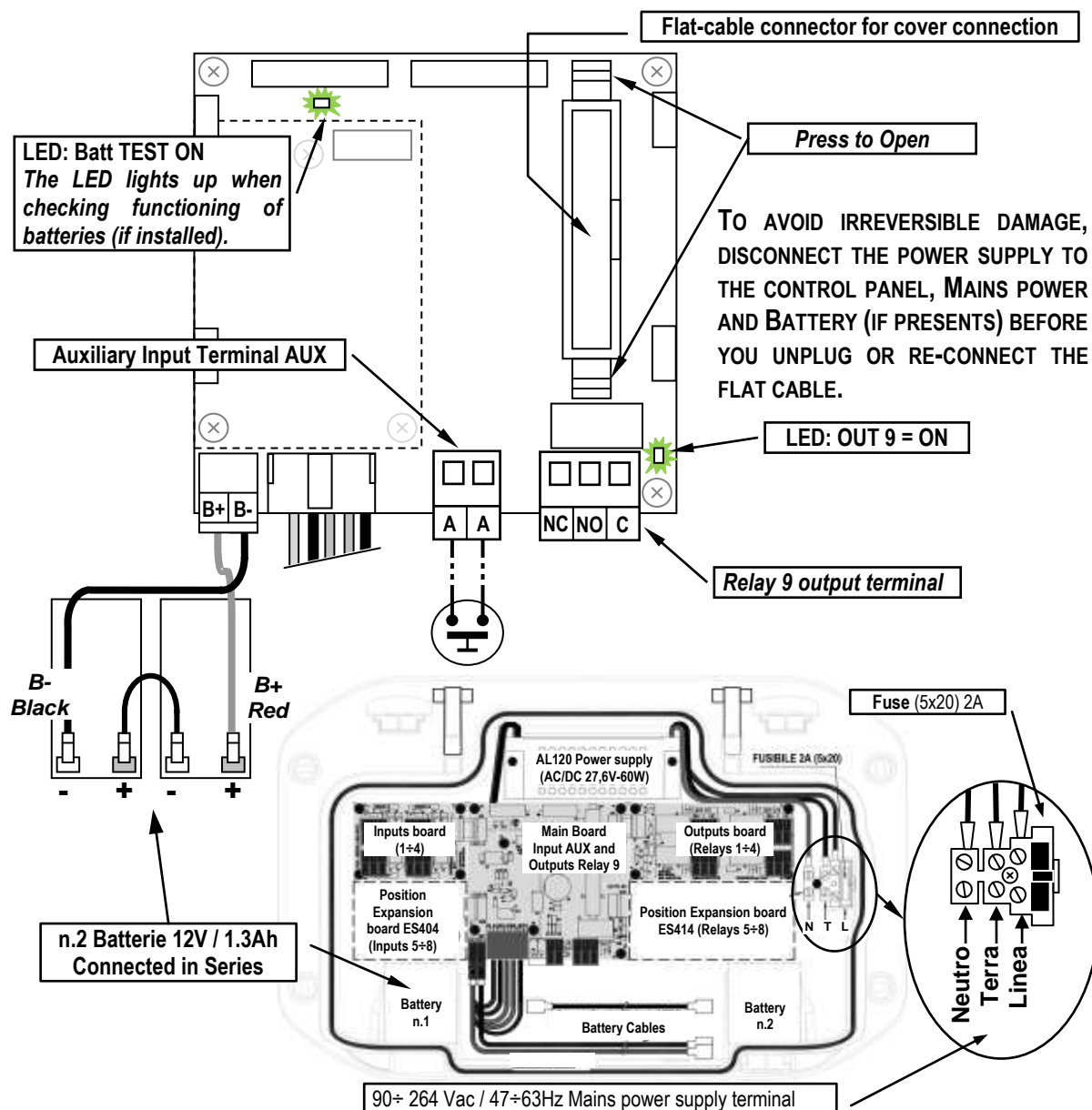

Fig 5 – CE408P Wiring diagram for Power, Batteries, AUX input and relay output No.9.

## Connection with Gas Detectors (Sensors)



**Please always refer to the specific instructions supplied with detectors.**



Please note that the Control Unit has a card with no.4 outputs. An **ES414** board can be installed to have a total of 9 outputs. In the diagrams, for simplicity, they are always indicated with all the Outputs.

**Cable section and distance between Control Unit and Sensors:** They must be 3-pole shielded cables, with a section suitable for the distance as indicated below in the table.

<i>Distanza massima di ogni rilevatore dalla centrale</i> <i>Maximum distance of each detector from the control panel.</i> <i>Distance maximale de chaque détecteur du panneau de contrôle</i>	<i>Tipo di Cavo schermato</i> <i>Shielded Cable Type</i> <i>Type de câble à écran</i>
Max. 200 metri / meters / mètres	3 x 1 mm <sup>2</sup> Schermato / Shielded / à écran
Max. 400 metri / meters / mètres	3 x 1,5 mm <sup>2</sup> Schermato / Shielded / à écran
Max. 600 metri / meters / mètres	3 x 2,5 mm <sup>2</sup> Schermato / Shielded / à écran

**Connection of the detectors: (Sensors 1÷8)** is carried out on the Input boards (4 ÷ 20mA) mounted in the base on the left, the terminals “+”, “-” and “S” must be connected to the corresponding terminals of the detector.

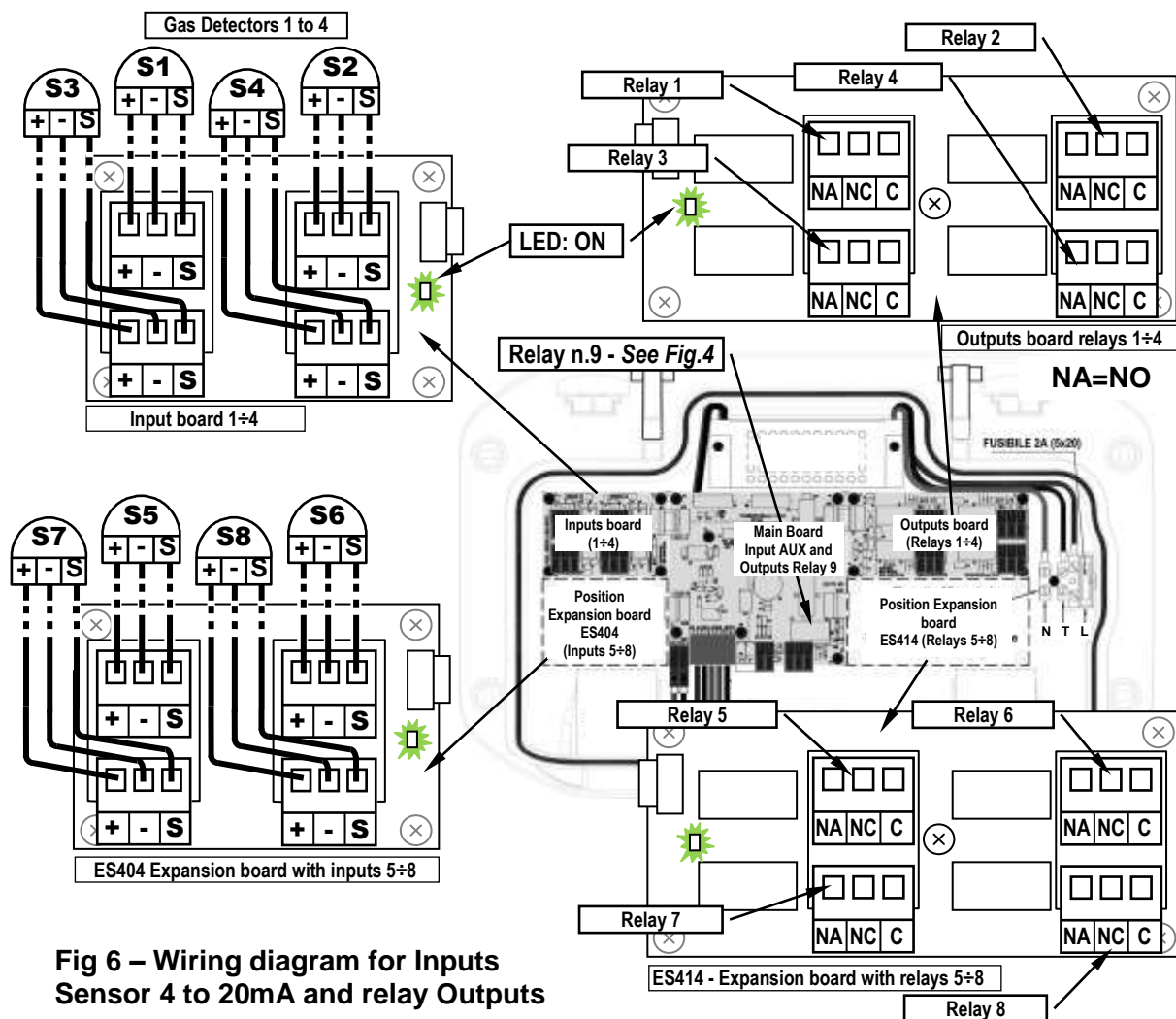

**Fig 6 – Wiring diagram for Inputs Sensor 4 to 20mA and relay Outputs**

The cable shield must be connected only from the Control Unit side and on a single "**EARTH**" point which must be equipotential. On each detector (sensor) it will be necessary to use two cable glands, one for the input and one for the output.



**IMPORTANT ADVICE:** before installing and configuring the control unit, evaluate how many alarm devices are connected to the relays to determine how many relays are needed and how they should act. [Please see in SENSORS> Configure> Description of the items related to the relay outputs.](#)



Please note that the unit has **No.5 outputs (relays)** that can be increased by installing the **ES414** expansion board to have a total of **9 outputs**. The diagrams, for simplicity, show all relays outputs.

**The connection to the internal outputs** (relays 1 to 9) should be performed on the outputs board, mounted in the base, on the right. The relay output no.9 is located on the central board, [see Figure 5](#). The relays nominal load is **250 VAC - 2 A** or **30 VDC – 2 A** (resistive load).

**NOTE:** in Italian the indication **NA** means **NO (Normally Open)** while the others are the same.

The relays have changeover free voltage contacts, on the boards, the indications **NO (Normally Open)**, **NC (Normally Closed)**, **C (Common)**, refer to the relays in the normal position (not powered). If an output is configured as **POSITIVE LOGIC**, the **NO** contact will become **NC** and **NC** will become **NA**.



**TO AVOID IRREVERSIBLE DAMAGE, DISCONNECT THE POWER SUPPLY TO THE CONTROL UNIT, MAINS POWER AND BATTERY (IF PRESENTS) BEFORE YOU UNPLUG OR RE-CONNECT, ANY EXPANSION CARD.**

## USE OF THE CONTROL UNIT

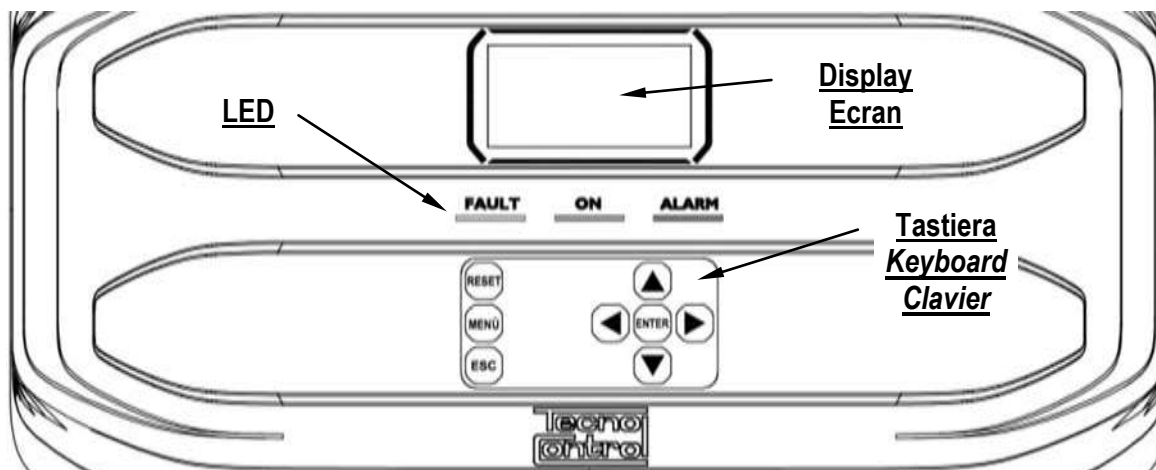







Fig.7 – CE408P Keyboard

- **Keyboard**

The keyboard is backlit. To save energy, the brightness is reduced to half after 10 seconds of non-use.

	<b>Can only be used on the main screen</b> , it is used to reset the latched outputs to normal operation, but only if the Sensor or Zone or Input has returned from the alarm condition. If there are active alarms, outputs configured as <b>Silenceable</b> (e.g. alarm) returns to normal operating conditions only for the time of <b>silencing</b> by default.
	Scroll through the display screens and the numeric digits up and down. Keeping the key pressed increases the values' speed scrolling. In the <b>main screen</b> changes to display the status of sensors, Logic Input and configured zones.
	Call up the <b>Main Menu</b> from any screen.
	Confirm the inserted data and in the <b>Main Screen</b> allows you to select the detail's sensors.
	Scroll through the pages (6 sensors at a time and 7 events at a time), and input fields. Keeping the key pressed increases the speed scrolling.
	Cancel an operation and in the <b>main screen</b> is used to enter to <b>Main Menu</b> .

- **LEDs indications**

The unit has 3 LEDs that show the operating status of the control unit ([see also appendix](#)).



<b>FAULT</b> (Yellow LED)	Flashing = Preheat (Start Unit) or in Service or Firmware Update. Fixed ON = Fault (Sensor or Areas) + Buzzer if enabled. Short flashing = Output relay associated with a latched Fault. Rapid flashing = Batteries Faulty or Disconnected.
<b>ON</b> (Green LED)	Fixed ON = Operation with mains power. Flashing = Operation with the batteries.
<b>ALARM</b> (Red LED)	Fixed ON = Alarm 3 is active (Sensor or Zone) + Buzzer if enabled. Flashing = Alarm 1 and / or 2 active (sensor or area or logic input). Short flashing = Alarm latched (indented) (sensor or area or logic input).

- **Internal Buzzer indication**

The unit has an internal buzzer that emits a **beep** when a key is pressed. It can also be configured to sound in the event of a Fault and / or an Alarm.



<b>Sound short (0.1s)</b>	<b>is always active</b>	Confirms the pressing of a key
<b>Continuous sound</b>	<b>if configured</b>	Fault (Sensor or Zone)
<b>Continuous sound</b>	<b>if configured</b>	Alarm 3 is active (Sensor or Zone)

- **Single digit numeric field (password entry, etc.)**

By pressing  and  key, the number is displayed in the field.

• **Screens 'Enable ...', 'Disable ...', 'Copy ...', 'Delete ...', 'Settings-> Date & Time':**

Pressing the first time,  key, the number is displayed in its field (deleting any existing number), and the next digits will be always inserted to the right of the number.



**Example:** to enter the number "12", press  once, then press  to move to the right and then press  twice.

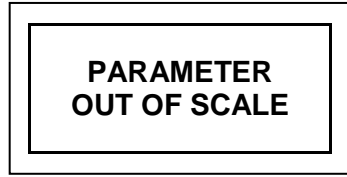

If the number exceeds the maximum acceptable value, message will appear "PARAMETER OUT OF RANGE".



• **Display – All other Screens:**

As above, but in addition, when you press the  key, the last digit entered will be erased and you can continue to enter additional digits.

**Example:** If you have entered the number "23", and then you want to change it to "25", simply press the  then press  5 times.





If you have already entered a single digit, pressing  will display the minimum value accepted by the field. Then, by pressing  or  key, the value already present is deleted and replaced with the new one.

• **Display – Initial Screens**

The unit, when powered, for 5 seconds shows the model name and the installed firmware version.



This information shall be *accessible* also in the menu **Settings→General→Info**. For more information read the chapter [Settings](#).

 **Only at first power (and only then)** will be asked to choose your language and to indicate if the battery is present. Use the key  and  to scroll through the languages and pressing the key  to confirm the choice.



If necessary, these choices can be changed. Please see forward [Service→Battery](#).

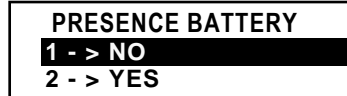

• **Preheating Time**

At each start-up, a decreasing count of **90 seconds** will always start, it is the time necessary for the control unit to start up and allow the Sensors to stabilize.

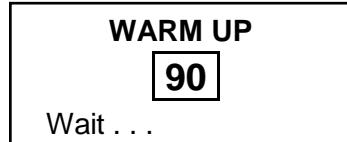



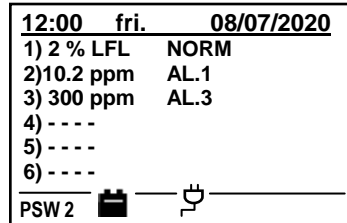

• **Display – Main Screen**

After the preheating time, appears the **main screen** that the control unit displays in normal operation. The date is shown in the top row, the first 6 sensors (*with the measured concentration and its state*) and in the last line, the battery status of charge (*if installed*) and presence of the mains. **PSW (PASSWORD)** followed by a number, at the bottom left indicates the current access level (*eg PSW 2 indicates that Level 2 is enabled*).



**Symbols used to indicate the status of the battery (if installed):**

				
Full Charge	Half Charge	Low Charge	Discharge	Flashing = Faulty or Disconnected



If by mistake, the battery (configured present) being disconnected and/or connected with the control unit, mains powered the yellow LED lights up on fast blinking.

**Symbols used to indicate the presence of mains power:**

 = mains operation (is absent, when the power is by the batteries).



If the control unit, had lost the date and time, due to a malfunction or discharge of the clock backup battery, screen will be displayed for entering updated values (The unit's safety functions are guaranteed, except those involving the use of date that will be wrong). By changing these parameters, see below, the section **SETTINGS** → **DATE and TIME**.

**The status of a sensor, which appears on the main screen, may be:**

----	<b>Not configured</b>	The detector is not Configured
****	<b>Disable</b>	Detector is disabling. The outputs (relay) are not activated if an alarm occurs.
<b>FAULT</b>	<b>Sensor failure</b>	General information, of a faulty detector
<b>NORM.</b>	<b>Normal</b>	There is no gas and there are no active alarms. The text blinks when relay output is latched ( <i>Detector or Zone, returned to normality after an alarm or a fault</i> ).
<b>AL.1</b>	<b>Alarm 1</b>	The first alarm threshold has been exceeded
<b>AL.2</b>	<b>Alarm 2</b>	The second alarm threshold has been exceeded
<b>AL.3</b>	<b>Alarm 3</b>	The third alarm threshold has been exceeded.







When a detector, a logic input or a zone, activate a relay output, the summary screen of the status of the Alarms and Faults appears. This allows checking quickly, the total number of active relays and their relative alarm level.

**The details of the individual items is as follows:**

<b>FAULT</b>	Indicates the number of active relays, relative to the <b>Fault</b> , of a sensor or a group of sensors that belong to a zone.
<b>AL. 1</b>	Indicates the number of active relays, relating to exceeding the <b>threshold of alarm 1</b> , of a sensor or a group of sensors that belong to a zone.
<b>AL. 2</b>	Indicates the number of active relays, related to exceeding the <b>threshold of alarm 2</b> , of a sensor or a group of sensors that belong to a zone.
<b>AL. 3</b>	Indicates the number of active relays, relating to exceeding the <b>alarm threshold 3</b> , of a sensor or a group of sensors that belong to a zone.
<b>INPUT</b>	Indicates the number of active relay, <b>LOGIC INPUT</b> .

The screen can be closed by pressing **ESC** or **RESET** key. If the alarms persist, the screen reappears after 10 minutes. If a new alarm occurs the screen will appear again automatically.



ALARM STATUS	
FAULT: 00	AL 1: 01
AL 2: 00	AL 3: 03
INPUT: 00	
Press Reset/Esc	



From the **Main screen**, by pressing  and  keys, to scroll through the sensors, displayed in groups of 6 at a time. Pressing  key highlights the sensor in the first row. While, using the keys  and  to scroll through the sensors (in the page) shown on the display. Pressing the  key again, you view the details of the highlighted sensor, (of course only if it is configured).

N. 1	
GAS:	METHANE
2 % LFL	5.60 mA
ZONE:	0
OUTPUT	
0 1 2 9	

**Explanations of the details are as follows:**

<b>1<sup>st</sup> row</b>	Shows the <b>number</b> of the sensor (Gas Detector).
<b>2<sup>nd</sup> row</b>	Shows the <b>name of the detected gas or its formula</b> .
<b>3<sup>rd</sup> row</b>	Shows the currently measured <b>gas</b> concentration and the <b>unit of measure</b> and current value (mA) ( <i>current generated by the sensor</i> ).
<b>4<sup>th</sup> row</b>	Indicates the <b>Zone</b> .
<b>5<sup>th</sup>-6<sup>th</sup> row</b>	Indicates the <b>output</b> number (Relay), corresponding respectively to: <b>1<sup>st</sup> Threshold (AL1) 2<sup>nd</sup> Threshold (AL2) 3<sup>rd</sup> Threshold (AL3) FAULT.</b> <b>Value 0 (zero)</b> indicates, at that threshold, the output not been assigned, while the <b>highlighted value</b> indicates that output relay is currently active ( <i>alarm</i> ). The values are real time updated.

Pressing  key it returns to the screen of the sensors. Press  again, to return to the **Main Screen**.

Using the keys  and  is displayed, in cyclic mode, the situation of the Zones (**from Z1 and Z2**) and the Logic Input **AUX (I1)**.

12:00 fri 08/07/2020  
Z1) NORM.  
Z2) - - - -

The status of a **LOGIC INPUT** can be configured LOW (normally open contact) or HIGH (normally closed contact) it can only be **ACTIVE** or **DEACTIVE**, while a **ZONE** has the same states as a Sensor, except the full scale.

12:00 fri 08/07/2020  
I1) LOW DEACTIVE

Press  to enter the **Main Menu**.





*The Control Unit has No. 2 Zones and No.1 Logic Input.*



## MAIN MENU

The Control Unit is provided with a **main menu** from which you can manage all of its functions.



The name of each line indicates the thematic area on which we can take action, by accessing the corresponding submenu.





Pressing  and  key to scroll through the menus.

Then press  to enter in the corresponding submenus.

*The Submenu 2-RESERVED, is not accessible, is not currently enabled, is reserved for other functions.*

<b>CE408</b>
<b>1 RESET</b>
<b>2 RESERVED</b>
<b>3 SENSORS</b>
<b>4 INPUTS</b>
<b>5 ZONES</b>
<b>6 EVENTS</b>
-----
<b>7 SETTINGS</b>
<b>8 PASSWORD</b>
<b>9 SERVICE</b>
<b>0 SD CARD</b>

 Some submenus are protected by **Level 1** or **Level 2** passwords, indicated by the "padlock" symbol visible when the level was not enabled.  
When a protected menu is selected, the request to enter the specific Password appears. When a menu is enabled, all others of the same level will be enabled and the "locks" disappear. Further information can be found in the [Access menu](#) section. 

With  and  you can enter the value, with  and  keys you can move from one number to another.

After entering the Password, move to **OK** and press .

If the password entered is correct, the window will confirm the operation.

If an incorrect password was entered, the window alerts you of the error and return to the screen **ENTER PASSWORD**

<b>ENTER PASSWORD</b>
<b>LEVEL 1</b>
<b>0000</b>
<b>OK</b>

 The required access level is indicated, when necessary, to the left of the individual items of the manual.

- List and short description of the accessible menus and the required ① or ② Password:

<b>1-RESET</b>	Performs silencing or Resetting the alarms and faults, not active and return to the main menu.
<b>2-RESERVED</b>	Submenu currently not active, reserved for further functions.
<b>3-SENSORS</b>	Enter a submenu where you can <u>enable</u> ①, <u>disable</u> ①, <u>configure</u> ②, <u>modify</u> ②, <u>copy</u> ②, <u>delete</u> ② and view the <u>details</u> of the sensors.
<b>4- INPUTS</b>	Enter a submenu where you can <u>enable</u> ①, <u>disable</u> ①, <u>configure</u> ②, <u>modify</u> ②, <u>copy</u> ②, <u>delete</u> ② and view the <u>details</u> of the logic input.
<b>5-ZONE</b>	Enter a submenu where you can <u>enable</u> ①, <u>disable</u> ①, <u>configure</u> ②, <u>modify</u> ②, <u>delete</u> ② and view the <u>details</u> of the zones.
<b>6- EVENTS</b>	Enter a submenu where it is possible to view, <u>all events</u> or ones related only to faults / alarms.
<b>7- SETTINGS</b>	Enter a submenu where you can change, the <u>language</u> ①, the display <u>Contrast</u> , the <u>buzzer</u> settings ①, <u>date and time</u> ① and display <u>Info</u> (model, version and business address).
<b>8- PASSWORD</b>	Enter a submenu where you can <u>enable</u> , <u>disable</u> , <u>modify</u> , the password, of the relative <u>access levels</u> ① and ②. The level ③ is not accessible, is factory reserved.
<b>9-SERVICE</b>	Enter a submenu where you can perform <u>electrical testing</u> ② of the control unit <u>manage the battery</u> ②, display the <u>status of the sensors</u> ②. <u>Factory Test</u> ③ is factory reserved.
<b>0-SD CARD</b>	Enter a submenu where you can <u>update</u> ② the Firmware of the control unit via an SD Card

## RESET

The **RESET** item in the main menu, performs the same function as  key, reset the latched outputs to normal operation, but only if the Sensor or Zone or Logic Input has returned from the alarm condition.

If there are active alarms, outputs configured as Silenceable (e.g. an alarm) return to normal operating conditions only for the *time of silencing*.

When performing the **RESET** (with key or from the menu), the display shows the confirm message for about 3 seconds, then the previous screen reappears automatically.



## SENSORS

In this submenu you can manage the sensors connected to the unit.

 The **3-CONFIGURE** menu, should only be used for a new sensor, to modify the parameters of an already configured sensor only use the **6-MODIFY** menu.

### SENSORS

1-ENABLE

2-DISABLE

**3-CONFIGURE**

4-COPY

5-DELETE

6-MODIFY

7-DETAILS



Below, the individual items are described in detail, with the same level password, which is indicated in parentheses.

### SENSORS-ENABLE / DISABLE (Level 1):

These two items allow you to enable or disable one or more sensors, even simultaneously.

A disabled sensor is displayed on the main screen, with "★★★★".





 **The Disabled sensors will no longer activate the fault and alarm outputs (relays) associated with them and therefore the devices connected to the relays will not be activated. This function can be used to exclude Sensors, not yet installed, in failure, be removed for repair or for a short time during maintenance, in order to avoid activating the alarms and then block a plant not yet put into safety.**

To **enable** or **disable** a sensor press  key on the relevant item highlighted. With  and  it is possible to select, if you take action on a single sensor or on a group of sensors.

### ENABLE

**SENSOR N.**

FROM N. TO N.

The first line, is acting on a single sensor. Pressing  on the 1<sup>st</sup>, will highlight the number of the sensor. Then you choose the desired number, with  and  keys and then, pressing  the confirmation window will appear.





### ENABLE

**SENSOR N.**

**FROM N. TO N.**

The 2<sup>nd</sup> line, acts on a group of sensors. Pressing  on the 2<sup>nd</sup> line, will highlight the 1<sup>st</sup> sensor's number of the group.



*If the two sensor numbers are the same, the effect is identical to the management of the single sensor.*

With  and , you can choose the number of required sensor, pressing  and  you change from one value to another, then pressing  again, confirmation window will appear.

### CONFIRM ?

YES = ENTER

NO = ESC

Press  to confirm, or to go back, press . If the sensor or one of the group's sensors is not configured, a window notifies you that the operation is not possible.

Then the screen returns to the selection of the sensor.



 **If you have selected a group of sensors, the ones that have been configured are enabled or disable.**

If the procedure is correct, a window warns that the operation has been successful. Then the screen returns to the start of the **Enable / Disable** management

```

SENSOR
      N. 1
ENABLE
  
```



**IMPORTANT:** Before starting the setup, decide how many and which outputs are to be used (relay) according to the type, to the requested operation and the number of actuators installed and in which the alarm levels are associated.

### CONFIGURE SENSORS (Level 2):

here are two ways to configure a sensor, but both can be configured only of our production models ([TABLES List detectors PRECONFIGURED](#)) that have some parameters not editable and others already preset, but it all changed, **must be entered only the outputs (relay number) you want to activate.**

The first way allows you to select, manually, one at a time sensor, including ones that are preconfigured.

The second way allows you can manually enter all the parameters, which are freely editable. This allows you to use compatible products but not of our production or new models not yet included in the list of pre-configured ones.

```

SENSORS CONFIG.
1 PRECONF. SENS.
2 GENERIC SENS.
  
```



**For safety, it is not allowed to set outputs separately. They can only be configured in CONFIGURE or MODIFY a Sensor, a Logic Input or a Zone.**

#### • CONFIGURE - PRECONFIGURED SENSOR:

To start the configuration press  on the relevant highlighted item. With  or  and then pressing  you can choose the number of the sensor to be configured.

```

PRECONF. SENS.
SENSOR N.      1
  
```



**For safety, if you choose a previously configured sensor, the screen that warns of the possible error, with you can confirm with  and continue, configuring it as if it were a new sensor, instead of pressing  will cancel the operation and you can choose another sensor.**

```

SENSOR USED
CONTINUE ?
YES= ENTER
NO= ESC
  
```



**The configuration of a dual sensor (TS255), uses 2 consecutive sensors (1-2, 3-4, or 2-3, 4-5 etc.) You should always start from the first configuration of the two.**

Next, you can choose the model code.

To choose the desired one, its structure must be followed as described below, first the first 2 letters must be chosen, then the 3 numbers and then the other letters (if present) until the complete code of the model is composed.

```

PRECONF. SENS.
SENSOR N.      1
MODEL:        TS
  
```



**CODE STRUCTURE:** our codes are made up of 2 letters that identify the type of product (e.g. **TS** = signal transmitter), 3 numbers that identify some functional characteristics, (e.g. **TS2xx** = mA signal output), other 2 or more letters specify the type of sensing element used and the gas detected, e.g. **TS282KM** (K=catalytic and M = Methane), other letters or numbers, if present, indicate other specific characteristics of the product.

With  and  you can scroll between the groups of letters and numbers that make up the model, with  you can confirm your choice and move on. With  you can go back.

```

PRECONF. SENS.
SENSOR N.      1
MODEL:        TS455
              TS282
              TS493
  
```

**Example:** for model **TS282KM**, first select **TS** and confirm by pressing . Then select the 2<sup>nd</sup> item **TS282** and confirm with  key. Finally complete the selection by selecting the complete entry **TS282KM** and press  to confirm.









```

PRECONF. SENS.
SENSOR N.      1
MODEL:        TS282KB
              TS282KG
              TS282KI
              TS282KM
  
```

Chosen model, will appear a short reminder referring to the configuration of voices **OUTPUT 1**, **OUTPUT 2** and **OUTPUT 3** that activates the corresponding alarm outputs (relays) and the specific parameters (delays) that define the operation mode of the relay outputs.

**CAUTION:** If the number of the relay will not be inserted, the alarm will not be activated.  
ENTER to exit

**Chosen model, will load its configuration.**

With  and  you can scroll through the various items. Press  on the item, it is only highlighted the value, editable with  and . With  and  you move from one field to the other in the same row (where applicable). The **ETIC** item, is explained later. Then by pressing  the change is accepted. With  the previous value is restored and the entire row is selected, indicating that it is possible to go back to scrolling through the various items.

**PRECONF. SENS.**  
 SENSOR N. 1  
 MODEL: TS282KM  
**TAG:**  
 TYPE: Flammable  
 GAS: METHANE  
 UoM: % LFL  
 AL: INCREASING



After the non-editable items, **MODEL**, **TYPE**, **GAS**, **UoM**, **F.S.** and **AL**. other fields have a presetted value but can be changed. The only empty fields are **OUTPUT 1**, **2** and **3** where the number of the relay that will activate the corresponding alarm level (**THRESHOLD 1**, **2** and **3**) must be entered.



**ATTENTION:** it is not mandatory to assign an **OUTPUT** relay number, but if it is not entered, alarm will not be activated. Number 0 (zero) indicates that no relay is assigned.



Only the configuration procedure of the two **HYSTER.OFF / TIME ON** functions is different from that described above, and must be carried out as explained in the following pages.







Chosen model, will appear a short reminder referring to the configuration of some particular parameters (delays) that define the operation mode of the relay outputs.

The explanation is detailed below in section **HYSTERESIS OFF**.

Pressing  the reading is confirmed and the pop-up disappears.

**NOTE:** to use the **TIME ON** parameter in the output settings, select **DELAY OFF** line and modify it with **ENTER** key.  
ENTER to exit

• **Description of items related to the Preconfigured sensor:**

<b>TAG</b>	<p>It is a 10-character label, selectable one at a time, where you can write a note or a reminder for a sensor (e. FLOOR 2, BOILER, etc.).  <b>AVAILABLE CHARACTERS:</b> 0 ÷ 9 A ÷ Z  (Space); ; &lt;=&gt;? @</p> <p>Pressing  on the item (when it is in negative), only the 1st character is highlighted, with  and , you scroll through the characters, with  and  you go to the next character, then complete the text, by pressing  you confirm the choice.</p>
<b>AL.</b>	<p>Defines the type of <b>ALARM</b> of the sensor and establishes how they should be set the thresholds of the various alarm levels. In the specific:  <b>INCREASING:</b> The alarm levels must be set from the smallest to the largest or, if needed, the same. (<b>ALARM 1 ≤ ALARM 2 ≤ ALARM 3 ≤ FULL SCALE of the SENSOR</b>). All our sensors, except for oxygen ones, are set with this type of alarm.  <b>DECREASING:</b> The alarm levels must be set from the largest to the smallest value or, if needed, the same. (<b>ALARM 1 ≥ ALARM 2 ≥ ALARM 3 ≥ FULL SCALE of the SENSOR</b>). Some oxygen sensors can be set with this type of alarm.  <b>OXYGEN:</b> Alarm levels should be set to detect concentrations lower (deficiency) or higher (excess) than the normal presence of oxygen in the air (20.9% v/v). (<b>ALARM 2 ≤ ALARM 1 ≤ 20.5% vol and ALARM 3 ≥ 21.2% vol and not beyond the FULL SCALE of the SENSOR</b>). Our oxygen sensors are set with this type of alarm.</p>



Only for Oxygen detectors, **ALARM 2** is displayed as **AL**↓, while the **ALARM 3** as **AL**↑

<b>ZONE</b>	<p><b>ZONE:</b> Sets the area that will be associated with the sensor. <b>The number of available areas is max 2.</b> The area <b>0</b> means that the sensor is not associated in any area</p>
<b>TLV</b>	<p>(<b>Threshold Limit Values</b>) are exposure limit values (<b>OELs-Occupational Exposure Limits</b>) for toxic substances to which workers may be exposed every day for the entire duration of working life without harmful effects. i.e. <b>SENSOR SCALE ≥ ALARM 3 ≥ ALARM 1 ≥ ALARM 2 ≥ FAULT</b> must be set in increasing order. Each alarm level is a value obtained with a temporal average. TLVs in detail are:</p>

**ALARM 1 = TLV-TWA** (Time-Weighted Average) is the *time-weighted average concentration* for a conventional **8-hour workday and a 40-hour workweek**, to which it is believed that nearly all workers may be repeatedly exposed, day after day, without adverse effect. This alarm is triggered when the weighted average concentration within **8 hours** exceeds the set threshold.

**ALARM 2 = TLV-STEL** (Threshold Limit Value–Short-Term Exposure Limit) is the concentration to which it is believed that workers can be *exposed continuously for a short period* of time without suffering from irritation, chronic or irreversible tissue damage, or narcosis. STEL **is defined as a 15-minute TWA exposure**, which should not be exceeded at any time during a workday. This alarm is triggered when the weighted average concentration in the last 15 minutes, exceeds the set threshold.

**ALARM 3 = TLV-C** (Threshold Limit Value-Ceiling) is the **concentration that should not be exceeded** during any part of the working exposure. This type of alarm is triggered when the instantaneous concentration exceeds the set threshold. Are not carried out, time weighted average.



**Only our sensors for detection of toxic gases can be set up with this type of alarm.**

**PARKING EN:** The alarm levels should be set so increasing, i.e. **SENSOR SCALE ≥ ALARM 3 ≥ ALARM 2 ≥ ALARM 1 ≥ FAULT**. In this case, the first two levels of alarm representing a value obtained with a time average between 5 and 60 min. (*according to standard EN 50545-1 for the car parks*). This value can be set via the parameter **TWA**. **ALARM 3**, however is instantaneous.



**This type of alarm (See Table 4) can only be set with our sensors for toxic gases in car parks (series TS282 and TS293 /EC/EN/EN2) or the dual sensors (series TS255).**

<b>THRESHOLD</b>	Indicates the value beyond which the relative Alarm level (Relay) will be activated. <b>THRESHOLD 1 = ALARM 1 associated with OUTPUT 1</b> <b>THRESHOLD 2 = ALARM 2 associated with OUTPUT 2</b> <b>THRESHOLD 3 = ALARM 3 associated with OUTPUT 3</b>
------------------	---



Each **THRESHOLD** has a hysteresis to prevent the relay output from activating and deactivating, if around its value. This hysteresis is 20% of the set value, for all sensor models, except for those that detect oxygen (TS... .EO) whose hysteresis is 2%.

- **Description of the items relating to the outputs:**

<b>OUTPUT</b>	Indicates the relay number that will be activated when the relative threshold is exceeded. The relays available ranging from <b>1</b> to <b>9</b> . The output set to <b>0</b> indicates that it is not associated with any relay. <b>OUTPUT 1 = RELAY for ALARM 1 activated by THRESHOLD 1</b> <b>OUTPUT 2 = RELAY for ALARM 2 activated by THRESHOLD 2</b> <b>OUTPUT 3 = RELAY for ALARM 3 activated by THRESHOLD 3</b>
---------------	--









**If the cards, with the relay outputs, are not mounted or correctly connected, for safety reasons the outputs cannot be configured.**

- If the **ES414** board is not connected to the 'OUT 5-8' terminal, the available outputs will only be from **1** to **4** and **9**.
- If no **ES414** card is connected, the only available output is **9**.

The operating mode of the relay outputs must be uniquely configured. The same relay output, used for different alarm levels, only the highest alarm configuration will be considered valid.



**It is not possible to choose the same output for an alarm level and a fault.**

<b>SILENCEABLE</b>	Indicates that the output is deactivated for the Silence Time when the <b>RESET</b> is performed. This function can be used, for example, for relay outputs connected to acoustic alarms The parameter can be set <b>YES</b> or <b>NO</b>
<b>SILENCE T.</b>	Is the <b>SILENCING TIME</b> , adjustable from 0 to 300 seconds for which a <b>SILENCEABLE</b> output is deactivated by means of the <b>RESET</b> . It can only be used if the <b>SILENCEABLE</b> parameter is set to " <b>YES</b> ".
<b>DELAY ON</b>	Is the delay, <b>HYSTERSIS ON</b> adjustable from 0 to 300 seconds, of the relay associated with an alarm threshold.
<b>DELAY OFF</b>	The item (in bold) <b>HYSTERSIS OFF</b> , which can be set from 0 to 300 seconds, is the delay of the relay it is associated with, to return to normal condition at the end of the alarm state.

**IMPORTANT NOTE for the HYSTERESIS OFF item:** by pressing  the item is selected, then with  and  it is possible to change it to **TIME ON** (see explanation of the function below). Then to program its value, press , set the value with  and , than press  to confirm. The **INST.OFF** and **TIME ON** functions cannot be used simultaneously or with the **LATCHED** function. For safety, if the delay is set other than zero, the **LATCHED** parameter will automatically become **NO**.

<b>TIME ON</b>	The second item, <b>TIME ON</b> , adjustable from 0 to 300 seconds, can only be used to stop the alarm output after a pre-set time, even if the sensor remains above the alarm threshold set. (It can be used to activate devices that cannot be powered on or to send a pulse to a phone-dialer).
<b>POS.LOGIC</b>	setting it to <b>YES</b> , indicates that the output operation is in <b>POSITIVE LOGIC</b> or the relay is normally activated, so, in case of failure automatically moves into the position of the alarm, and then the NC contact becomes NO.
<b>LATCHED</b>	Setting it to <b>YES</b> , indicates that the relay remains in alarm, even if the sensor back below the alarm set. To bring it back into the normal, <b>RESET</b> must be performer.

 The function **latched**, cannot be used simultaneously with **DELAY OFF** or **TIME ON**. For safety, if the parameter **latched**, was set **YES**, the parameters **DELAY OFF** and **TIME ON**, will be automatically set to Zero.

Then at the end of the screen, **SAVE** appears. Pressing  will prompt you to save the configuration entered. Press  again to confirm, or  to go back to make changes.

 Only for double sensors, **TS255** series, at the end of the screen, the message **CONTINUE** appears. Because in this case, must be programmed two consecutive sensors. Only after the second configuration, you can save the configuration entered.

If there are incorrect parameters, a warning will appear, in particular:

**If the alarm thresholds set**, were in contrast with the criteria for the type of alarm set.

**If a same relay output already used and configured**, as possible, it was associated with another level of alarm and / or fault (**FAULT**) but with modified operating parameters, compared to those already configured for the same output.

Then the screen returns to the configuration of the sensor.

**ERROR  
CONFIGURATION  
CONTROL PARAMETERS**

If the procedure is correct, the window warns that the operation was successful; the configured sensor is enabled and active.

Then the screen returns to the choice of the type of configuration.

**SENSOR  
N. 1  
ENABLED**

#### • CONFIGURE - GENERIC SENSOR:

This item allows you to manually enter all the parameters, which are freely editable. This allows you to use compatible products but not of our production or new models not yet included in the list of pre-configured ones. To start configuration, press  on the relevant item.

With  or  and then pressing  you can choose the number of the sensor to be configured.

*It proceeds in the same way as described in the **CONFIGURE SENSORS** chapter, in the paragraphs: [Descriptions of items relating to the Preconfigured Sensor](#) and [Description of items relating to the relay outputs](#).*

**SENSORS CONFIG.  
1 PRECONF. SENS.  
2 GENERIC SENS.**

**GENERIC SENS.  
SENSOR N. 1**

*In this case, however, you can also change the following items:*

#### • Description of the items relating to the GENERIC SENSORS:





<b>TYPE</b>	It indicates the gas that the sensor will detect. You can choose between <b>Flammab.</b> (Flammable), <b>Toxic, Vital</b> (e.g. Oxygen), <b>Asphixian.</b> (e.g. CO2 is asphyxiating) and <b>Refriger.</b> (Refrigerant e.g. R134a).
-------------	--

<b>GAS</b>	It indicates the name of the gas for which the sensor has been calibrated. You can choose between METHANE, LPG, PETROL (Petrol vapours), HYDROGEN, VARIOUS (various gases), STYRENE, ACETYLENE, AMMONIA, CO, CO <sub>2</sub> , H <sub>2</sub> S, NO, NO <sub>2</sub> , SO <sub>2</sub> , HCN, OXYGEN, CL <sub>2</sub> e HCL.
<b>UoM</b>	It indicates the unit of measurement of the concentration detected by the sensor. You can choose between %LFL ( <i>Lower Flammable Limit</i> ), %vol (Volume), ppm ( <i>parts per million</i> ), ppb ( <i>parts per billion</i> ) and °C (temperature in degrees Celsius).
<b>RANGE</b>	It shows the sensor's full scale. It consists of four digits and you can also set the decimal point. The numbers allowed, ranging from a minimum of 1, 0.1 or 0.01 up to a maximum of 9999, 99.9 or 9.99. Other values or combinations are not accepted and, if entered, will display the previous value.



### SENSORS-COPY (Level 2):

This item allows you to copy the configuration of a sensor to another sensor or group of sensors.

To copy a sensor, press  on its item.

On the screen, press , then with  and  you can choose which Sensor to copy. Press to confirm. Then, with  and , you can choose whether to copy to a single sensor or to a group.

The 1st line acts on a single sensor. Pressing  on the 1st line the sensor number will be highlighted.

Then with  and  you can choose the desired number, then by pressing  the confirmation window will appear.





The 2<sup>nd</sup> line instead acts on a group of sensors. Pressing  on the 2<sup>nd</sup> line will highlight the number of the first sensor in the group.



COPY  
SENSOR N. 1

COPY  
SENSOR N. 1  
ON SENSOR N.  
FROM N. TO N.

COPY  
SENSOR N. 1  
ON SENSOR N.  
FROM N. TO N.

 *It is possible to copy all sensors between 2. Either from the smallest to the largest number, or the other way around. If 2 numbers were the same, the effect is like managing the single sensor.*

With  and  you choose the desired sensor number, with  and  you go from one extreme to the other. Then pressing  the confirmation window will appear.

To confirm press . To go back, press . Each time it is pressed, it will return to the previous stage.

CONFIRM ?  
YES = ENTER  
NO = ESC

If the sensor to be copied is not configured, a window warns that the operation is not possible.

Subsequently the screen returns to the choice of the sensor.

STOP  
SENSOR  
N. 1  
NOT CONF.

If this procedure is correct, a window notifies you that the operation has been successful.

Then the screen returns to the beginning of the copy management

SENSOR N. 1  
COPIED  
FROM N. 2 TO N. 4

### SENSORS-DELETE (Level 2):

This item allows you to delete a **Sensor** or a **Group of Sensors** from the configuration.

*The access level and the procedure is the same as described in the previous paragraph [COPY](#).*

After choosing the sensor or sensors and confirming with  the window, it will warn you that the operation was successful.

Then the screen returns to the beginning of the **CANCEL** management.





SENSOR  
N. 1  
DELETED

**SENSORS-MODIFY (Level 2):**

It must be used to modify an already configured sensor, press  on the relevant item. Then choose the sensor number to be modified, excluding the non-modifiable items: **MODEL., TYPE, GAS, UoM., F.S., AL.** scroll through the parameters and choose the one you want to modify, with the same procedure described in the paragraph [CONFIGURE PRECONFIGURED SENSOR](#).

**SENSORS-DETAILS:**

To see the parameters of an already configured sensor, press  on the relevant item.

Once the desired Sensor number has been chosen, the items are as in the configuration of a Sensor. You can scroll through them with  and . Then at the end of the screen, the sensor enabling status is also indicated. Finally, scrolling to one of the lines with the number of the output, if it is different from zero, pressing  displays the details. The items of the output details (relay) are scrolled with  and . At the end of the screen, the silence status of the output is indicated.

THRESHOLD_1 :	7
OUTPUT_1 N. :	0
THRESHOLD_2 :	10
<b>USCITA_2 N. :</b>	<b>2</b>
THRESHOLD_3 :	20
OUTPUT_3 N. :	3

**LOGIC INPUT**

In this submenu it is possible to manage the **LOGIC INPUT (AUX)**, to which it is possible to connect devices with a **NO** (Normally Open) or **NC** (Normally Closed) contact such as Gas sensors with relay outputs, Smoke Sensors, Buttons, etc. . . .



*The access level, the procedure and the items are as explained in the [SENSORS](#) section.*

**INGRESSO**

- 1-ENABLE
- 2 DISABLE
- 3 CONFIGURE**
- 4 COPY
- 5 DELETE
- 6 MODIFY
- 7 DETAILS

**LOGIC INPUT - ENABLE/DISABLE (Level 1):**

*The access level, the procedure and the items are as explained in the [SENSORS-ENABLE/DISABLE](#) section.*



These two items allow you to enable or disable the **LOGIC INPUT**. The "disabled" status is displayed on the main screen, next to the Input, with the symbol "★★★★".



***The disabled input no longer activates the associated relay output and therefore the devices connected to it will not be activated. This function can be used to exclude devices that have not yet been installed or failed or removed for repair.***

If the procedure is correct, a window notifies you that the operation has been successful. Then the screen returns to the beginning of the enable / disable management of the **LOGIC INPUT**.









**LOGIC INPUT – CONFIGURE (Level 2):**

In the **INPUTS** submenu, press  on the item for **CONFIGURE**. Then on the screen, press  to configure the **Logic Input**.

<b>INPUT CONFIG.</b>	
INPUT N.	<b>1</b>



*Remember that the Control unit has only one logical input*

With  and  you scroll through the different items and then pressing only the value is selected, showing that you can change it. Then with  and  you change the values, while with  and  you go from field to field on the same line (where applicable) and then pressing  the change is accepted. Instead, pressing  restores the previous value and the entire row is selected, showing that it is only possible to scroll through the various items.

The various items are explained in detail below:

**Description of items relating to Logic Inputs**

<b>ACTIVE</b>	<b>Indicates the status of the input. LOW means that it will go into ALARM when the circuit is open (e.g. button). HIGH mean it will go into ALARM when closed.</b>
---------------	---

<b>INPUT CONFIG.</b>	
INPUT N.	<b>1</b>
<b>ACTIVE :</b>	<b>LOW</b>
OUTPUT N. :	0
SILENCE MODE :	NO
SILENCE TIME:	NO
DELAY ON :	0s
DELAY OFF :	0s



**Description of items relating to Outputs (relays):**

The description of the items: **OUTPUT N, SILENCEABLE, SILENCE, HYSTER.ON, HYSTER.OFF/TIME ON, POS LOGIC** and **LATCHED** are identical to those of the chapter, **CONFIGURE SENSORS**

Then at the end of the screen, move to **SAVE** to save the configuration entered. By pressing the confirmation window will appear. Press again to confirm, or press to go back.

After confirming, a window warns that the operation was successful. Then the screen returns to the **INPUTS** configuration.

```
INPUT
      N. 1
CONFIGURED
```

**LOGIC INPUT – DELETE (Level 2):**

To delete the **LOGIC INPUT** from the configuration. Press on the relevant item **and then proceed in the same way as described in the paragraph SENSORS-DELETE**

Press to confirm or to return to the previous step. (If the Input was not configured, the window warns that the operation is not possible). After confirming, the window will notify you that the operation was successful.

Then the screen returns to the beginning of the Delete management.

```
DELETE
INPUT N.      1
```

```
INPUT
      N. 1
DELETED
```

**LOGIC INPUT - MODIFY (Level 2):**

To modify a configured **LOGIC INPUT**, press on the relevant item **and then proceed in the same way as described in the paragraph SENSORS - MODIFY**

**LOGIC INPUT – DETAILS:**

To see the parameters of the already configured Logic Input, press on the relevant item. After choosing the input, as in the configuration, the related items and the number of the corresponding relay output are shown. To go back, press .

You can scroll through the items with and . Then at the end of the screen, the operating and enabling status of the input are indicated. Finally, by selecting the line with the number of the output, if different from 0, you can view the details by pressing .

The items can be scrolled with and . In addition, at the end of the screen, the output silencing status is indicated.

```
INPUT DETAILS
INPUT N.      1
ACTIVE       :      LOW
OUTPUT N.    :      2
STATUS      :      ALTO
ENABLE      :      SI
```

**ZONES**

In this submenu it is possible to manage the **ZONES**, to which it is possible to associate the Sensors.

**The access level, the procedure and the items are as in the SENSORS section**

```
ZONES
1 ENABLE
2 DISABLE
3 CONFIGURE
4 DELETE
5 MODIFY
6 DETAILS
```

The **ZONES** can be used in various ways, compatibly with the number of relay outputs available:

**A** - Group several sensors of the same type and use the same outputs (relays) for all of them, configuring them only in the zone. In this case, in the individual sensors configure only the alarm thresholds and the number of outputs all at 0. When the sensors belonging to the zone exceed the set thresholds, they will activate the relative relay outputs, following the chosen operating logic.

**B** - Group different sensors but placed in the same room or on the same floor. In this case, in the individual sensors, also configure the relay number in the outputs, while in the ZONE set in the outputs only the numbers of the relays common to the sensors associated with that ZONE.

**ZONES - ENABLE/DISABLE (Level 1):**

The access level and the procedure are as described in the **SENSORS-ENABLE / DISABLE** section

These two items allow you to **Enable** or **Disable** one or more **ZONES** at the same time. The **Disable** status is displayed on the main screen, next to the Input, with the symbol "★★★★".



**The disabled ZONE no longer activates the associated relay output and therefore the devices connected to it will not be activated. This function can be used to exclude devices that have not yet been installed or failed or removed for repair.**

If the procedure is correct, a window notifies you that the operation has been successful. Then the screen returns to the beginning of the **Enable / Disable** management of the **ZONES**.

### ZONES - CONFIGURE (Level 2):

In the **ZONES** submenu, press on the item for **CONFIGURE** to configure the **ZONE**.

On the screen, pressing , then using and you choose the number of the **ZONE** to be configured.

ZONES CONFIG.

ZONE N. **1**



Remember that the Control unit **has 2 ZONES and 2 outputs (relays) for each single alarm level, plus a fault output, for a total of 9 configurable outputs (relays) for each Zone. The fault output, if configured, intervenes if any sensor in the Zone is faulty.**

With and you scroll through the different items and then pressing only the value is selected, showing that you can change it.

Then with and you change the values, while with and you go from field to field on the same line (where applicable) and then pressing the change is accepted. Instead, pressing restores the previous value and the entire row is selected, showing that it is only possible to scroll through the various items.

The various items are explained in detail below:

- **Description of items related to the Zone:**

**LOGIC** | It defines the logical operator to activate of the outputs (*relay*) on the thresholds:

- **OR (logical sum):** The outputs relating to thresholds are triggered when one or more sensors in the area exceed its threshold. **(It is the normal operation, each sensor activates the alarms at exceeding of the set threshold)**
- **AND(logical product):** The outputs relating to thresholds, are triggered only when all the sensors in the area exceeds its threshold.
- **CORR.CON (Correspondent Consecutive):** The outputs relating to thresholds are triggered when two consecutive sensors in the area exceed its threshold. The last and the first are not considered consecutive (e.g. installation along a corridor).
- **CIRC.CON (Circular Consecutive):** The outputs relating to thresholds are triggered when two adjacent sensors in the area exceed its threshold. The last and the first are considered consecutive (e.g. installation in a circle).
- **PARK-ITA(Only for Italy, Parking in accordance with the Italian Ministerial Decree):** The outputs relating to thresholds are triggered when two sensors belonging to the zone exceeds its threshold. This configuration must be used if the control unit for garages must be programmed in accordance with **Ministerial Decree 02.01.1986 (point b of paragraph 3.9.3)** and subsequent **Ministerial Decree 03/08/2015 - D.M. 21/02/2017**.

- **Description of the items relating to the outputs:**



[The description of the items: OUTPUT N, SILENCEABLE, SILENCE, HYSTER.ON, HYSTER.OFF/TIME ON, POS LOGIC and LATCHED are identical to those of the chapter, CONFIGURE SENSORS](#)

Then at the end of the screen, move to **CONTINUE** (relay output configurations relating to **THRESHOLD 1** and **THRESHOLD 2**). Press to continue until the configuration screen of the outputs relating to **THRESHOLD 3** and **FAULT** (failure). Finally, move to **SAVE**, to save the configuration entered.

By pressing the confirmation window will appear. Press again to confirm or to go back. If the procedure is correct, the window warns that the operation was successful.

Then the screen returns to the **CONFIGURE ZONES** screen.

ZONE

N. 1

CONFIGURED

**ZONES-DELETE (Level 2):**

This item allows you to delete a **ZONE** or a group of **ZONES** from the configuration.

<b>DELETE</b>
<b>ZONE N.</b> 1
FROM N. TO N.



*The access level procedure is explained in the [SENSORS-DELETE](#) section.*

After choosing, choose whether to act on a single **ZONE** (1<sup>st</sup> line) or on a group of **ZONES** (2<sup>nd</sup> line) and confirming with the window, it will warn you that the operation was successful.

Then the screen returns to the beginning of the **CANCEL** management.

<b>ZONE</b>
N. 1
<b>DELETED</b>



By deleting a **ZONE**, the relay outputs configured in it will no longer be available.

**ZONES-MODIFY (Level 2):**

To modify a configured **ZONE**, press on the relevant item and then proceed to modify the parameters in the same way as the configuration as described in the [ZONES - CONFIGURE](#) paragraph.

**ZONES-DETAILS:**

To see the parameters of the already configured **ZONE**, press on the relevant item.

Once the **ZONE** has been selected, as in configuration, the items relating to the zone and the number of relative relay outputs are shown.

You can scroll through them with and . Then, at the end of the screen, the operating and enabling status of the **ZONE** is indicated.

Finally, scrolling to one of the lines with the number of the output, if it is different from zero, pressing displays the details. The items of the output details (relay) are scrolled with and . At the end of the screen, the silence status of the output is indicated.

<b>ZONES DETAILS</b>
ZONE N. 1
LOGIC : OR
OUTPUT 1 THRESH 1
<b>OUTPUT N. : 2</b>
OUTPUT 2 THRESH 1
<b>OUTPUT N. : 3</b>

**EVENTS**

In this submenu it is possible to view the last 100 events stored by the control unit and sorted from the most recent to the oldest.



*The control unit stores the events cyclically, that is, after No.100; the oldest event is always deleted.*

**EVENTS - ALARMS / FAULTS:** Only those relating to **Sensors**, **Logic Inputs**, **Zones** and Relay **Outputs** can be displayed.

**EVENTS - ALL:** the generic events memorized by the control unit, including those of **Presence** or **Absence of mains**, **Switching on** and **Reset** of the control unit.

<b>EVENTS</b>
<b>1 ALARMS/FAULTS</b>
2 ALL

The items are scrolled with and . Then press on the chosen item. The screen shows the date, time and type of event. Events are displayed in groups on the same day starting with the most recent. Then with the and keys you scroll through the events and days.

**EVENTS - ALARMS / FAULTS:**

**First line:** is the date of the event, in the format dd / mm / yy (**Day / Month / Year**).

**Each subsequent line is an event**

**First part on the left:** is the time of the event, in the format hh/mm/ss (*Hours/Minutes/Seconds*).

**Second part on the right:** this is the type of event as follows:

**First letter:** indicates the object to which the event refers:

<b>S</b> = SENSOR	<b>I</b> = LOGIC LOGICO	<b>Z</b> = ZONE	<b>U</b> = OUTPUT (relay).
-------------------	-------------------------	-----------------	----------------------------

**Two numbers:** they are the number of the object to which the event refers.

**State:** it is the new state reached by the object that caused the event.

The **LOGIC INPUTS** can have 2 states:

**ATT.** (*Active, in alarm*) or **DIS.** (*Off, returned to normal*).

The **OUTPUTS** (relays) can have 3 states:

**ATT.** (*Active, in alarm*), **DEA.** (*Deactivated, returned to normal*) or **SIL.** (*Alarm Silenced*).

**SENSORS** and **ZONES** can have 6 states:

**FLT** (*Fault*), **NORM** (*Normal*), **OVS.** **↑** (*Over Scale*),

**AL1** (*Alarm 1 exceeded*), **AL2** (*Alarm 2 exceeded*) or **AL3** (*Alarm 3 exceeded*).

**EVENTS - ALL**

Generic events, which can be viewed from the **ALL** menu, can have 4 states:

**POWER ON** - *the control unit has been switched on.*

**MAIN YES** - *the control unit is mains power supply, only if batteries are installed.*

**MAIN NO** - *the control unit is powered only by batteries, if installed.*

**RESET** - *Reset performed from keyboard or menu.*

**SERV.1** (*Electrical Test performed - Service Function*).

**SERV.2** (*Battery Test performed - Service Function*).

**Example:** in the screen, on the left.

**The first line** indicates that you are seeing those of July 08, 2020.

**The second line** shows that, at 15, 12 minutes and 3 seconds (**15:12:03**) the sensor no.2 (**S 02**) has exceeded the threshold of ALARM 1 (**AL 1**).

**The third line** shows that, at 14, 45 minutes and 21 seconds (**14:45:21**), the output relay no.5 (**U 05**) have been activated (**ACT.**).



**The fourth line** shows that, at 10, 38 minutes and 57 seconds (**10:38:57**) LOGIC INPUT number 1 (**I 01**) has been deactivated and returned to NORMAL operation (**DEA.**).

In the **other rows**, there are no events.

EVENTS	08/07/2020
15:12:03	S 02 AL1
14:45:21	U 05 ACT.
10:38:57	I 01 DEA.
NO EVENT	
NO EVENT	
NO EVENT	







**SETTINGS**

In this submenu it is possible to manage the control unit settings.

Scroll the list with  and , with  select the desired item.

SETTINGS
<b>1 LANGUAGE</b>
2 CONTRAST
3 BUZZER
4 DATE and TIME
5 INFO

**SETTINGS-LANGUAGE (Level 1):**



To change the language of the control unit, press  on the relevant item. With  and  chooses the desired one, then press . The confirmation window will appear. To go back press  or press  to confirm. The window will warn that the operation was successful.



Then the screen returns to the beginning of the **SETTINGS** management.

LANGUAGE
1 ITALIAN
<b>2 ENGLISH</b>
3 FRENCH
4 SPANISH

SETTINGS SAVED
-------------------



## SETTINGS-DISPLAY CONTRAST

Press  on the item and then adjust the value with  and .

Having obtained the desired effect, pressing  the confirmation window will appear. Press  again to confirm or  to go back. A window will warn you that the operation was successful. Then the screen returns to the beginning of the **SETTINGS** management.







<b>ADJUST</b>
1 CONTRAST <span style="float: right;"><b>14</b></span>

## SETTINGS-BUZZER (Level 1)









Choose whether to activate the **BUZZER** inside the Control unit, if a sensor or zone failure or alarm occurs. Press  on the item and then, with  and  keys and choose which item to modify.

- **ALARMS:** If set to **YES**, the internal buzzer of the control unit is activated if a sensor or a zone enters the **Alarm** state.
- **FAULTS:** If set to **YES**, the internal buzzer of the control unit activates if a sensor or a zone enters a **Fault** state.

<b>BUZZER</b>
ALARMS: <span style="float: right;"><b>NO</b></span>
FAULTS: <span style="float: right;">NO</span>

To modify these parameters press  and change the value with  and . Once the desired value has been chosen, by pressing  the confirmation window will appear. Finally press  to confirm or  to go back. After confirming, the window will warn that the operation was successful. Then the screen returns to the beginning of the **SETTINGS** management.

## SETTINGS-DATE and TIME (Level 1):

To change date and time press  on the item. With  and  you change the values, with  and  you move from one field to another. Then move to the word "**SAVE**" and press . The confirmation window will appear. Press  to go back, or  to confirm, the window will warn you that the operation was successful. Then the screen returns to the beginning of the **SETTINGS** management.

<b>TIME</b>
<b>10</b> : 15
<b>DATE</b>
08 / 07 / 2020
SAVE

If an impossible date had been entered (e.g.: 30/02 / ....) the window will warn of the error.

Then the screen will return to changing the **DATE and TIME**.

<b>DATE NOT VALID</b>
-----------------------



**The control unit has an internal battery that powers the clock when the unit is turned off. If date and time are required on power, the backup battery may be discharge and / or faulty, please contact our customer service for replacement.**

## SETTINGS-INFO

In this submenu you can view the model, the Firmware version, and the contacts (postal address, telephone and email address). Press  to go back.

<b>CE408</b>	<b>Ver.2.0X</b>
TECNOCONTROL srl	
Via Miglioli, 47	
20054 Segrate (MI) ITALY	
Tel +39 02 26922890	
info@tecnocontrol.it	

## PASSWORD

In this submenu you can manage the levels of access to the password protected menus. Press  on the relevant item.

<b>PASSWORD</b>
<b>1 ENABLE</b>
2 DISABLE
3 MODIFY

**The PASSWORD Level 1 and Level 2 are factory-set to 0000**



**Please note that the accessible levels are only the first two:**

**LEVEL 1:** intended for the User





**LEVEL 2:** intended for the Installer or Maintenance Technician

**LEVEL 3 is reserved only for the Manufacturer (Tecnocontrol).**

## ENABLE LEVEL:

This item allows you to enable the relative access level.

Press  on the relevant item.

With  and  you can enter the value, with  and  keys you can move from one number to another.

After entering the Password, move to **OK** and press .

If the password entered is correct, the window will confirm the operation. Then the screen returns to the beginning of the **PASSWORD** management.

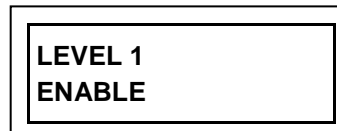
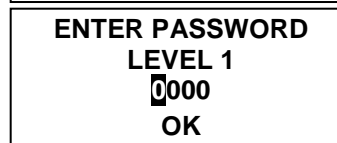
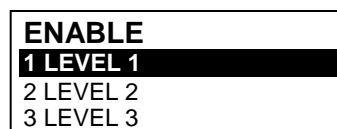

*When a protected menu is selected, the request to enter the specific Password appears. Once enabled, the number of the enabled access level appears in the lower left corner of the main screen. In addition, the padlocks  of the level enabled disappear.*





*For safety, after one hour, all access levels are automatically disabled.*

If an incorrect password was entered, the window alerts you of the error and return to the screen **ENTER PASSWORD**



## DISABLE LEVEL

This item allows you to **disable all active access levels**.

Press  on **DISABLE**, the confirmation window will appear. The operation is confirmed with  and with  cancel the operation. Then the window will warn that the operation was successful.

Then the screen returns to the beginning of **PASSWORD** management.

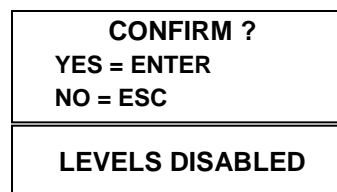

## CHANGE PASSWORD:

This item allows you to **change the password** of the relevant access level.

Press  on the relevant item. The screen will appear, asking you to enter the old password first and then the new one.

If the old password is wrong, the window will warn of the error and then return to the password entry screen.

If, on the other hand, the operation is correct, after entering the new password, the window will warn that the operation was successful.

Then the screen returns to the beginning of the **PASSWORD** management.

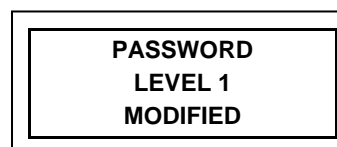

*If the password for an access level were lost or forgotten, you can be changed by inserting as the old password, to a higher level of access.*

**Example:** if the Level 1 password is lost, it can be changed by entering the Level 2 password as the old password



**At the end of the programming it is recommended to insert new passwords for Level 1 and Level 2 in place of the factory "0000" ones. When entering new passwords, always remember to write them down and keep them in a safe place. In case of loss of passwords, contact our assistance service.**

## SERVICE





***This procedure must be performed with extreme care by authorized and trained personnel. Before proceeding, make the system safe, as both the relay outputs, which will activate the connected devices, and the internal functions of the control unit will be activated.***

In this submenu it is possible to manage the maintenance functions of the control unit.



***The FACTORY TEST item is not accessible; it is reserved only for the Manufacturer (Tecnocontrol).***

By pressing  on the relevant item, a reminder (pop-up) will appear to inform you to put the system in safety mode, because the Control unit will enter a special state, during which the alarm outputs (relays) will be blocked and therefore also the devices connected to the relays will no longer be activated. The outputs (relays) and therefore devices connected to the relays can be activated only for **ELECTRIC TEST - RELAY**, for all the other functions they will not be activated. Press 

to accept, or  to go back. The reminder disappears automatically after 5 seconds.

### SERVICE

- 1 **ELECTRIC TEST**
- 2 BATTERY
- 3 SENSORS STATUS
- 4 FACTORY TEST

**ATTENTION !**  
BEFORE PROCEEDING,  
PUT SYSTEM IN  
SAFETY  
ENTER to confirm or ESC



***This function excludes gas detection for the time required for maintenance. For safety, the control panel will restore normal operation after 60 minutes if the function is not used. If the function will be confirmed within 5 minutes of the expiry, this time will be reset and another 60 minutes will be available.***







### SERVICE-ELECTRIC TEST (Level 2):

By pressing  on the relevant item. The screen will appear where you can choose which test to perform.

To start a test, press  on the relevant item:







### ELECTRIC TEST

- 1 **DISPLAY**
- 2 KEYBOARD
- 3 LED/BUZZER
- 4 OUTPUTS (Relay)
- 5 AUX
- 6 SD CARD

- **DISPLAY:** for 3 sec, all the pixels of the display will be switch on, and then the previous screen returns.
- **KEYBOARD:** the screen with the keys name will appear, displayed as the keyboard. When a key is pressed, if it is working, the corresponding name is highlighted on the display. To end the test and return to the previous screen, press  twice.
- **LED / BUZZER:** 1<sup>st</sup> the yellow, green and red LEDs switch off, then switch on in sequence; then for 1 second, the Buzzer will activate. When finished, the previous screen will automatically reappear.
- **RELAY:** The test checks if the output cards are installed, the display will show only the numbers of the internal relays present. Those configured in positive safety are in bold. Use  and  to move the cursor to the desired relay, press  to change its status. At the end of the test, press  to return to the previous screen.
- **AUX:** checks the operation of the **Logic Input**. The display will show its status, i.e. whether the contact is OPEN or CLOSED. Changing its state verifies whether it works. Press  to return to the previous screen.
- **SD CARD:** check if the memory card is present. The display will show if the SD Card is PRESENT or ABSENT. If the SD card is inserted but not detected, it may be inserted incorrectly or the card holder is broken. Press  to return to the previous screen.

**SERVICE-BATTERY (Level 2):**

Pressing  on the relevant item, you can choose if the battery is installed, or manually perform the function test and display the battery voltage.

Then with  and  keys, you can choose the item to edit. Pressing  you can change the value using  and  key. After choosing the desired value, press  to confirm or press  to go back.







<b>BATTERY</b>	
PRES. BATT.	<b>NO</b>
TEST BATT :	NO
V.BATT. :	27,51

 *The battery test is automatically performed every day. If there is no voltage, the battery test cannot be executed and will be suspended if it is in progress.*

 **The control unit will be automatically powered by the batteries in the event of a mains failure. To avoid damaging the batteries (excessive discharge) below 22 VDC the control unit will automatically shut down. When mains power is present, the battery will be recharged and kept charged.**  
*If the batteries (configured present) were disconnected, with the control unit powered by the mains, the yellow LED will flash quickly. Reconnecting the batteries will restore normal operation.*

**PRES. BATT. (Presence Battery):**

- When set **NO**, the battery is not present. In the main screen, the icon in the bottom left will be absent and if there is no mains power, the control unit will shut down.
- When set **YES**, indicating the presence of the battery. In the main screen, the icon in the bottom left indicates the charge status of the battery according to the following scheme:





 <b>Full charge</b> 26.5 VDC about	 <b>Partially charge</b> 24÷26.5 VDC.	 <b>Half charge</b> 22 ÷ 24 VDC.	 <b>Low battery</b> 20.7÷22 VDC.	   <b>Flashing</b> 00.0 VDC = <b>Disconnected</b> <at 20.7 VDC or> at 28 VDC = <b>Faulty</b> <b>Replace the two batteries.</b>
---	---	---	---	---

**TEST BAT. (Test Battery):**

- When set **YES**, it is activated or indicates that the test is in progress. The test takes about a minute, and checks, with a load, the proper functioning of the battery. If during the test, the battery voltage drops below 20.7 VDC, is reported as a **Fault** (see above), and the battery will not be recharged. **The test will not be activated in the absence of mains or battery.**
- When set **NO**, the test indicates that you disable or do not on the battery test.

 *When Battery Test is active, on the power board, placed in the base of the housing, its LED will light, (**BAT TEST ON**). Consider that the two power resistors (load) will heat up during the test.*

**SERVICE SENSORS STATUS (Level 2):**

This item allows you to view the current value of the connected sensors. Press  on the relevant item. The value of the sensors will be displayed, with  and  you scroll through all the sensors. To go back, press .

<b>SENSORS STATUS</b>	
1)	1 04.00 mA
2)	05,23 mA
3)	04,05 mA
4)	12,38 mA
5)	12,00 mA
6)	11,58 mA

**SERVICE-FACTORY TEST (Level 3)**

***This item is not accessible, it is reserved for factory settings.***  
 If you try to enter, a message warns you that access is denied.

	<b>LEVEL NOT ENABLED ACCESS DENIED Press Esc</b>
---	--

**SD CARD**

In this submenu it is possible to manage the SD-Card, after having inserted it in its seat. The card housing is on the circuit in the cover, inside the case.

<b>SD CARD</b>
<b>1 UPDATE FIRMWARE</b>

 **The compatible SD-Cards are of the SD and SDHC type up to 32Gb. SDXC's must be formatted with FAT32 (max 32Gb). Normally the control unit accepts all SD Cards, however it is recommended to use those from qualified manufacturers.**



**UPDATE FW. (Level 2):** This item allows you to **Update the Firmware** of the control unit using the file loaded on an SD-Card. The file must be downloaded from our website "[www.cpftecnogeca.com](http://www.cpftecnogeca.com)" in the **DOWNLOAD>SOFTWARE>CE408 Firmware Update area** by following the relative instructions.

Press **ENTER** on the relevant item, the procedure to be performed before starting the update will be displayed. Then press **ENTER** to start the update or press **ESC** to go back.

**UPDATE FIRMWARE**  
INSERT IN THE  
CONTROL UNIT  
THE JUMPER JP3  
THE SD CARD  
AND PRESS ENTER

**i** **First, move the jumper JP3 in the position "CLOSED" and then insert the SD-Card into its slot (see below figure 12).**

Scheda posta nel Coperchio.  
Board into housing cover.

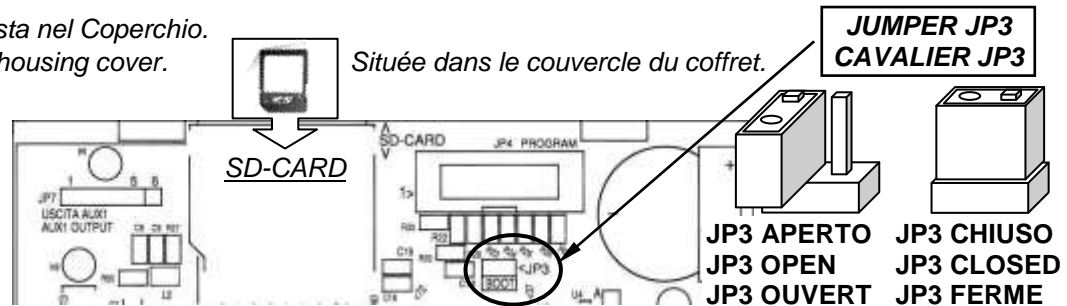

**Fig.12-SD-Card insertion**



**If the above procedure is correct, the control unit restarts. Otherwise the control unit does not continue.** The control unit checks that there is a valid file on the SD Card for updating. If there is more than one, the file with the latest version is loaded.

When the control unit restarts, the automatic firmware update begins, which lasts about 3 ÷ 5 minutes. This phase is indicated by the flashing of the yellow LED and the message on the display.

If there is no file on the SD Card or there is a firmware version that is previous or equal to the one already installed, the control unit will report it and then restart without updating.

If the SD Card is not readable, the control unit will report it and then restart normally

If the SD Card was write protected.

If the SD-Card is not inserted or is not detected, the control unit will report it and then restart normally. Check that you have correctly inserted the card and, if necessary, check its operation by testing (see menu **Service** → **Electric Test** → **SD Card**).

At the end of the update, a message will confirm that the operation is finished, in addition, the green LED and the buzzer will light up for 3 seconds. After that, the control unit will restart in normal operation.

If the update was not carried out correctly, the display will inform you that the operation has failed and for 3 seconds, the red LED and the buzzer will light up. Then it will automatically restart in normal operation, but with the previous Firmware version.



**Put Jumper JP3 back in the "OPEN" position, otherwise, at each restart, the control unit will check if there is an update file on the SD Card.**

**Firmware may be incomplete.** This would be reported when the control unit restarts. In this case, try to power down and power up the control unit and repeat the update. If the problem persists, check the integrity of the update file by loading the previous working firmware version. If not, contact the supplier.

**WAITING**  
**UPDATE IN PROGRESS**

**FIRMWARE MISSING**  
**OR JUST PRESENT**

**SD CARD**  
**NOT READABLE**

**SD CARD**  
**WRITE PROTECTED**

**SD CARD**  
**MISSING**

**UPDATE**  
**SUCCEEDED**

**UPDATE**  
**FAILED**

**FIRMWARE**  
**CORRUPT**

## APPENDIX

TECHNICAL SPECIFICATIONS	
AC power supply and frequency	90 to 264 V AC / 47 to 63 Hz
AC Maximum consumption <sup>(1)</sup>	1,6A a 110VAC / 1A at 230V AC
Max current delivered by the power supply	1,4 A a 27,6VDC
Number of detectors that can be connected	Max no. 8 (inside the CE408)
Analog Input 4 to 20 mA (Linear)	No. 8 maximum, of which no.4 factory installed, others are expandable to 8 with expansion board ES404
Analog Input - Load resistance	RL (inside of each input) = 100 ohm
Voltage / current limits for each input.	24 VDC (-10/+15%) / 100 mA (with resettable current limiter)
Relay outputs (with voltage free changeover contacts)	No.5 factory installed, expandable to 9 with ES414 expansion card. ( <b>Available on request</b> )
Nominal load of relay (SPDT contact on each relay)	250 VAC – 2 A or 30 VDC – 2 A resistive load.
Logic Input	No. 1 (setting for NA or NO dry contacts)
SD Card type accepted	SD e SDHC max 32Gb SDXC formatted by PC with FAT32 (max 32Gb).
Display	monochrome LCD graphical display with backlight
Optical indications	No. 3 LED (Yellow, Green and Red)
Acoustic indications	Internal Buzzer
Keyboard	No. 8 keys with backlight
Backup battery ( <b>optional</b> ) <sup>(2)</sup>	NO. 2 Pb 12VDC / 1.3Ah (connected in series)
Max Charging Current from Power Supply	0.75 A a 27.6VDC
Battery operating time <sup>(3)</sup>	about 1h30' with 4 detectors, 1h with 8 detectors.
Operating temperature/humidity (with the batteries installed in the control unit)	+5 to +40 °C / 5 to 95% relative humidity
Dimensions and Protection rating <sup>(4)</sup> .	379 x 241 x 133 mm / IP42 <sup>(4)</sup>
Weight (without the batteries)	about 2 Kg
Weight of the internal batteries only	(No.2x1.3Ah) about 1.2 Kg

(1) With all the internal detectors connected and 9 relays activated.

(2) Batteries are not included. If greater autonomy is required, 2 12V 3Ah or 7Ah Pb batteries connected in series can also be used, but due to the size, they must be installed in an external container.



*The autonomy, with 3Ah batteries, becomes: about 3h30' with 4 detectors, 1h15' with 8 detectors.*

*The autonomy, with 7Ah batteries, it becomes: about 8h with 4 detectors, 5h10' with 8 detectors.*

(3) Battery autonomy is calculated in the worst conditions, with all relays configured in Positive Logic and also considering a negative coefficient due to possible effects on battery efficiency (aging, temperature, etc.).

(4) Using Metric Cable Glands (M16 and M20 Pitch ISO 1,5mm) with IP55 or higher protection degree.

## Summary of the list of Fault and Alarm messages

STATUS	DISPLAY	Yellow LED	Green LED	Red LED	Buzzer configured
Sensor not Configured	----		Fixed ON		
Sensor or Zone in Fault	FAULT	Fixed ON	Fixed ON		Activated
Sensor or Zone returned from a Fault, but with output relay latched.	NORM (Blinking)	Short blinking <sup>(2)</sup>	Fixed ON		
Sensor operating normally	NORM		Fixed ON		
Battery Operation - (with graphical indication, from Full Charge up to Discharge)			Blinking <sup>(1)</sup>		
Batteries Fault	 Blinking <sup>(1)</sup>	Rapid blinking <sup>(3)</sup>	Fixed ON		
Sensor or Zone or Logic Input, in Alarm 1	AL 1		Fixed ON	Blinking	
Sensor or Zone or Logic Input, in Alarm 2	AL 2		Fixed ON	Blinking	
Sensor or Zone in Alarm 3	AL 3		Fixed ON	Fixed ON	Activated
Sensor or zone or logic input, with Alarm 3 returned to normal, but with relay output latched.	NORM Blinking		Fixed ON	Short blinking <sup>(2)</sup>	
Sensor over the Full Scale	F.S.	Fixed ON	Fixed ON	Fixed ON	

(1) Blinking = 1sec ON / 1sec OFF / (2) Short blinking = 0,1sec ON / 1sec OFF / (3) Rapid blinking = 0,1sec ON / 0,1sec OFF

DISPLAY MESSAGE	EXPLICATION
LEVEL NOT ENABLED ACCESS DENIED	Password protected menu. The requested access level has not been enabled
RESET DONE	RESET performed (activates the SILENCABLE Outputs and restores the LATCHED relays)
SENSOR NOT CONFIGURED	The sensor is not installed or not configured, the function is not executable
OUTPUT NOT CONFIGURED	The Output (relay) is not configured
INPUT NOT CONFIGURED	The Logic Input is not configured, the function is not executable
ZONE NOT CONFIGURED	The Zone is not configured, the function is not executable.
CONFIGURATION ERROR CHECK PARAMETERS	One or more parameters entered in the configuration of a sensor are not correct or in contrast with others already entered
OUT OF SCALE PARAMETER	Too high a numeric value was entered.
INVALID DATE	Time or date entered not possible
WRONG PASSWORD	Wrong level code (Password) entered
FIRMWARE MISSING OR JUST PRESENT	The firmware version is older or the same as the one already installed or the update file is not present in the SD-Card.
NO SD CARD	The SD-Card is not inserted in the control unit. (If it is, the card holder is faulty).
SD CARD NOT READABLE	The SD-Card is inserted, but it cannot be used (replace or format it).
SD WRITE PROTECTED	The SD-Card is inserted, but write-protected
CORRUPT FIRMWARE	The control unit is unable to start, incomplete or missing firmware.
UPDATE FAILED	The Control unit is unable to update the Firmware from the SD-Card

## TABLES with List of PRECONFIGURED Gas Detectors

### TABLE 1 – Models with 4÷20mA output and Replaceable Sensor Cartridge.

WITH CATALYTIC SENSORS FOR FLAMMABLE GASES					Alarm levels		
MODELS	Detected Gas	RANGE	UNIT	Threshold 1(AL1)	Threshold 2(AL2)	Threshold 3(AL3)	
TS282 KB TS292 KB <sup>(4)</sup> TS293 KB	PETROL vapors	0÷20	%LFL	7 <sup>(1)</sup>	10	20	
TS282 KG TS292 KG <sup>(4)</sup> TS293 KG	LPG (Butane)						
TS282 KI TS292 KI <sup>(4)</sup> TS293 KI	HYDROGEN						
TS282 KM TS292 KM <sup>(4)</sup> TS293 KM	METHANE						
WITH PELLISTOR SENSORS FOR FLAMMABLE GASES					Alarm levels		
MODELS	Detected Gas	RANGE	UNIT	Threshold 1(AL1)	Threshold 2(AL2)	Threshold 3(AL3)	
TS282 PB TS292 PB <sup>(4)</sup> TS293PB	PETROL vapors	0-100	%LFL	8 <sup>(1)</sup>	12	20	
TS282 PG TS292 PG <sup>(4)</sup> TS293PG	LPG (Butane)						
TS282 PI TS292 PI <sup>(4)</sup> TS293PI	HYDROGEN						
TS282 PM TS292 PM <sup>(4)</sup> TS293PM	METHANE						
TS282 PX <sup>(A)</sup> TS293PX <sup>(A)</sup> TS292 PX <sup>(4)</sup> TS293PX-H <sup>(A)</sup>	FLAMMABLE						
TS293PE	Acetylene						
TS293PS	Styrene						
<b>NOTE (A): for the TS282PX, TS293PX and TS293PX-H models, the list of FLAMMABLE gases for which the detector can be calibrated are indicated in the instructions for the specific model.</b>							
WITH INFRARED (NDIR) SENSORS FOR FLAMMABLE GASES					Alarm levels		
MODELS	Detected Gas	RANGE	UNIT	Threshold 1(AL1)	Threshold 2(AL2)	Threshold 3(AL3)	
TS293 IB	Petrol vapors	0-100	%LFL	8 <sup>(1)</sup>	12	20	
TS293 IG	LPG (Butane)						
TS293 IM	METHANE						
TS293 IX	FLAMMABLE						
WITH ELECTROCHEMICAL SENSORS FOR TOXIC GASES					Alarm levels		
MODELS	Detected Gas	RANGE	UNIT	Threshold 1(AL1)	Threshold 2(AL2)	Threshold 3(AL3)	
TS282 EA TS293 EA TS282 EA-H TS293 EA-H	NH <sub>3</sub>	0-300	ppm	10	20	50	
TS282 EC-S TS293 EC-S TS282 EC-H TS293 EC-H	CO	0-300	ppm	25	50	150	
TS282 ECL	CL <sub>2</sub>	0-10.0	ppm	0.3	0.5	1.0	
TS282 EH TS293 EH	H <sub>2</sub> S	0-100	ppm	10	20	50	
TS282 EHCL	HCL	0-10.0	ppm	3.0	5.0	10.0	
TS282 EHCN TS293 EHCN	HCN	0-10.0	ppm	2.0	3.0	5.0	
TS282 EN TS293 EN	NO	0-100	ppm	10	20	50	
TS282 EN2 TS293 EN2	NO <sub>2</sub>	0-30.0	ppm	3.0	6.0	15.0	
TS282 ES TS293 ES	SO <sub>2</sub>	0-20.0	ppm	5.0	7.5	10.0	

**NOTE TO TABLE 1:** Discontinued **TS220E** (Electrochemical sensors) models are configurable using the **TS282E** codes and the only construction difference is the enclosure used.

WITH ELECTROCHEMICAL SENSORS FOR VITAL GASES					Alarm levels		
MODELS	Detected Gas	RANGE	UNIT	Threshold 1(AL1)	Threshold 2(AL2)	Threshold 3(AL3)	
TS282 EO TS293 EO	Alarm <sup>(6)</sup> =OXYGEN Configurable	O <sub>2</sub> 0÷25.0	% vol	19.5	18.5 <sup>(2)</sup>	22.5 <sup>(3)</sup>	
	Alarm <sup>(6)</sup> =DECREASING			20.0	19.5	18.5	

WITH INFRARED (NDIR) SENSORS FOR ASPHYXIATING GAS					Alarm levels		
MODELS	Detected Gas	RANGE	UNIT	Threshold 1(AL1)	Threshold 2(AL2)	Threshold 3(AL3)	
TS282 IC2 TS293 IC2	CO <sub>2</sub>	0-5.00	% vol	0.50	1.00	2.00	
TS282 IC2-H TS293 IC2-H	CO <sub>2</sub>	0-5000	ppm	1000	1800	2500	
TS210 IC2 IR101-IR102 <sup>(4)</sup>	CO <sub>2</sub>	0-2.00	% vol	0.20	0.50	1	

GAS DETECTORS WITH TWO SENSORS FOR PARKING					Alarm levels		
MODELS	Detected Gas	RANGE	UNIT	Threshold 1(AL1)	Threshold 2(AL2)	Threshold 3(AL3)	
TS255 CB	CO	0-300	ppm	30	60	150	
	PETROL vapors	0-20	% LFL	7 <sup>(1)</sup>	10	20	
TS255 CN2	CO	0-300	ppm	30	60	150	
	NO <sub>2</sub>	0-30.0	ppm	3.0	6.0	15.0	

WITH SEMICONDUCTOR SENSOR FOR REFRIGERANT GAS					Alarm levels		
MODELS	Detected Gas	RANGE	UNIT	Threshold 1(AL1)	Threshold 2(AL2)	Threshold 3(AL3)	
TS282 SFx-H TS293 SFx-H	Refrigerant	0-1000	ppm	400	600	1000	

WITH (NDIR) SENSORS SENSOR FOR REFRIGERANT GAS					Alarm levels		
MODELS	Detected Gas	RANGE	UNIT	Threshold 1(AL1)	Threshold 2(AL2)	Threshold 3(AL3)	
TS282 IFn	Refrigerant	0-2000	ppm	400	600	1000	
TS282 IFn-H		0-1000	ppm				

**NOTE: the list of REFRIGERANT gases for which the detector can be calibrated are indicated in the instructions for the specific model.**

**TABLE 2 - Models with DISPLAY and Replaceable Sensor Cartridge**

WITH PELLISTOR SENSORS FOR FLAMMABLE GASES					Alarm levels		
MODELS	Detected Gas	RANGE	UNIT	Threshold 1(AL1)	Threshold 2(AL2)	Threshold 3(AL3)	
TS593 PG	LPG (Butane)	0-100	%LFL	8 <sup>(1)</sup>	12	20	
TS593 PM	METHANE						
TS593PX-H	FLAMMABLE						
TS593 PE	Acetylene						
TS593 PS	Styrene						

WITH INFRARED (NDIR) SENSORS FOR FLAMMABLE GASES					Alarm levels		
MODELS	Detected Gas	RANGE	UNIT	Threshold 1(AL1)	Threshold 2(AL2)	Threshold 3(AL3)	
TS593 IG	LPG (Butane)	0-100	% LFL	8 <sup>(1)</sup>	12	20	
TS593 IM	METHANE						
TS593 IB	PETROL vapors						
TS593 IX	FLAMMABLE / FLAMMABLES						

WITH ELECTROCHEMICAL SENSORS FOR TOXIC GASES					Alarm levels		
MODELS	Detected Gas	RANGE	UNIT	Threshold 1(AL1)	Threshold 2(AL2)	Threshold 3(AL3)	
TS593 EA TS593 EA-H	NH <sub>3</sub>	0-300	ppm	10	20	50	
TS593 EC-S TS593 EC-H	CO	0-300	ppm	25	50	150	
TS593 EH							
TS593 EHCN							
TS593 EN							
TS593 EN2							
TS593 ES							

WITH ELECTROCHEMICAL SENSORS FOR VITAL GASES					Alarm levels		
MODELS	Detected Gas	RANGE	UNIT	Threshold 1(AL1)	Threshold 2(AL2)	Threshold 3(AL3)	
TS593 EO	Alarm <sup>(6)</sup> =OXYGEN Configurable	O <sub>2</sub>	0÷25.0	% vol	19.5	18.5 <sup>(2)</sup>	22.5 <sup>(3)</sup>
	Alarm <sup>(6)</sup> =DECREASING				20.0	19.5	18.5

**TABLE 3 - Models with Fixed Sensor (Parking, Heating Plants, Civil installations)**

WITH CATALYTIC SENSORS FOR FLAMMABLE GASES					Alarm levels		
MODELS		Detected Gas	RANGE	UNIT	Threshold 1(AL1)	Threshold 2(AL2)	Threshold 3(AL3)
SE192 KB	SE193 KB	PETROL vapors	0÷20	%LFL	7 <sup>(1)</sup>	10	20
SE192 KG	SE193KG	LPG (Butane)					
SE192 KI	SE193KI	HYDROGEN					
SE192 KM	SE193KM	METHANE					
	SE193 PB	PETROL vapors	0÷100	%LFL	10 <sup>(1)</sup>	15	20
	SE193PG	LPG (Butane)					
	SE193PI	HYDROGEN					
	SE193PM	METHANE					
WITH ELECTROCHEMICAL SENSORS FOR TOXIC GASES					Alarm levels		
MODELS		Detected Gas	RANGE	UNIT	Threshold 1(AL1)	Threshold 2(AL2)	Threshold 3(AL3)
SE192 EC	SE193 EC	CO	0-300	ppm	25	50	150

**NOTE TO TABLE 3:** The SE183 models can be configured using the SE193 code and the only construction difference is the enclosure (Exd) used.

**NOTES TO THE TABLES 1 and 2:**

- (1) It is not recommended to set pre-alarm levels lower than the value indicated.
- (2) the Alarm for oxygen deficiency is displayed as **AL.↓**.
- (3) the Alarm for oxygen excess is displayed as **AL.↑**.
- (4) Product discontinued or no longer in stock.
- (5) **N.A.** Data Not Available
- (6) indicates the Alarm Type selectable in the sensor configuration. It is preconfigured as OXYGEN but can be changed to DECREASING , if the excess alarm is not needed.

**TABLE 4 - Models and Values of TLVs**

MODELS						Alarm levels		
		Detected Gas	RANGE	UNIT	TLV-TWA Threshold 1	TLV-STEL Threshold 2	TLV-Ceiling Threshold 3	
TS282 EA	TS293 EA TS293 EA-H	TS593 EA TS593 EA-H	NH <sub>3</sub>	0-300	ppm	25 <sup>(COSH)</sup> / <sup>(OSHA)</sup>	35 <sup>(COSH)</sup>	50 <sup>(OSHA)</sup>
TS282 EC-S	TS293 EC-S TS293 EC-H	TS593 EC-S TS593 EC-H	CO	0-300	ppm	30 <sup>(COSH)</sup>	200 <sup>(COSH)</sup>	250
TS282 ECL			CL <sub>2</sub>	0-10.0	ppm	0.5 <sup>(OSHA)</sup>	0.5 <sup>(COSH)</sup>	1.0
TS282 EH	TS293 EH	TS593 EH	H <sub>2</sub> S	0-100	ppm	5 <sup>(COSH)</sup>	10 <sup>(COSH)</sup>	20
TS282 EHCL			HCL	0-10.0	ppm	5.0 <sup>(OSHA)</sup>	5.0 <sup>(COSH)</sup>	10.0
TS282 EHCN	TS293 EHCN	TS593 EHCN	HCN	0-10.0	ppm	4.7 <sup>(OSHA)</sup>	10 <sup>(COSH)</sup>	4.7 <sup>(OSHA)</sup>
TS282 EN	TS293 EN	TS593 EN	NO	0-100	ppm	25 <sup>(COSH)</sup> / <sup>(OSHA)</sup>	25 <sup>(COSH)</sup>	50 <sup>(OSHA)</sup>
TS282 EN2	TS293 EN2	TS593 EN2	NO <sub>2</sub>	0-30	ppm	3.0 <sup>(COSH)</sup>	5.0 <sup>(COSH)</sup>	15.0
TS282 ES	TS293 ES	TS593 ES	SO <sub>2</sub>	0-20.0	ppm	2 <sup>(COSH)</sup>	5 <sup>(COSH)</sup>	10
TS282 IC2	TS293 IC2	TS593 IC2	CO <sub>2</sub>	0-5.00	% vol	0.50 <sup>(COSH)</sup> / <sup>(OSHA)</sup>	1.50 <sup>(COSH)</sup>	3.00
TS282 IC2-H	TS293 IC2-H	TS593 IC2-H	CO <sub>2</sub>	0-5000	ppm	1000	1500	5000 <sup>(COSH)</sup> / <sup>(OSHA)</sup>
TS210 IC2			CO <sub>2</sub>	0-2.00	% vol	0.50 <sup>(COSH)</sup> / <sup>(OSHA)</sup>	1.50 <sup>(COSH)</sup>	2.00



The values indicated refer to the requirements of the bodies that deal with the health of workers, the European **COSH** (Control Of Substances Hazardous to Health) and the US **OSHA** (Occupational Safety and Health Administration). The indicated values may change according to national standards.

**TABLE 5A-Pre-configured values for PARKING-EN (EN50545-1)**

MODELS						Alarm levels		
		Detected Gas	RANGE	UNIT	TWA minutes	Threshold 1 (AL1)	Threshold 2 (AL2)	Threshold 3 (AL3)
TS282 EC-S	TS293 EC-S	CO	0-300	ppm	15	30	60	150
TS282 EC-H	TS293 EC-H							
TS282 EN	TS293 EN	NO	0-100	ppm	15	10	20	50
TS282 EN2	TS293 EN2	NO <sub>2</sub>	0-30	ppm	15	3.0	6.0	15.0
TS255 CB		CO	0-300	ppm	15	30	60	150
TS255 CN2		CO	0-300	ppm	15	30	60	150
		NO <sub>2</sub>	0-30.0	ppm	15	3.0	6.0	15.0



As indicated in the standard EN50545-1, the **TWA** values, shown in [Table 4](#), can be set from 5 to 60 minutes, while the delay of the relay activation, in **HYST.ON** (Hysteresis ON) **THRESHOLD 3**, can be set from 60 to 300 seconds.

**TABLE 5B - USED ONLY IN ITALY - Values to be set to use with PARKING-ITA**

					<b>Alarm levels</b>		
<b>MODELS</b>		<b>Detected Gas</b>	<b>RANGE</b>	<b>UNIT</b>	<b>Threshold 1(AL1)</b>	<b>Threshold 2(AL2)</b>	<b>Threshold 3(AL3)</b>
TS282 EC-S TS282 EC-H	TS293EC-S TS293 EC-H	CO	0-300	ppm	30	50	100
TS282KB	TS293KB	PETROL vapors	0-20	% LFL	7	10	20
TS255CB		CO	0-300	ppm	30	50	100
		PETROL vapors	0-20	%LFL	7	10	20

**This function can be applied only in Italy, where garages must comply with the D.M. 3 August 2015 - Fire Prevention Code (and related updates, Ministerial Decree 21 February 2017, Section V - Vertical technical rules - V.6 Garage activities).**



If CO detectors and gasoline vapor detectors were used for better management of the ventilation system); it is recommended to use the configuration indicated above in the table.

Associate the CO detectors to the same zone, setting the logic as PARK-ITA, the output relating to THRESHOLD 2 must be configured in the programming of the outputs available for the ZONE (OUTPUT\_1\_THRESHOLD\_2, OUTPUT\_2\_THRESHOLD\_2). While for gasoline vapor detectors, THRESHOLD 1 and THRESHOLD 2 may not be used, but the output relating to THRESHOLD 3 must be configured in the programming of all individual sensors.

**TABLE 6 - PRECONFIGURED Parameters of Relay Output Operation****SENSORS FOR FLAMMABLE GASES**

Relay Number	ALARM	Silenceable	Hysteresis ON (seconds)	Hysteresis OFF (seconds)	Time ON (seconds)	Logique Positive	Latched Output
1	AL1	NO-NON	5	0	0	NO-NON	NO-NON
2	AL2	NO-NON	10	0	0	NO-NON	NO-NON
3	AL3	NO-NON	30	0	0	SI-YES-OUI	SI-YES-OUI
4	FAULT	NO-NON	45	0	0	SI-YES-OUI	NO-NON

**SENSORS FOR TOXIC AND asphyxiating gases (CO<sub>2</sub>)**

Relay Number	ALARM	Silenceable	Hysteresis ON (seconds)	Hysteresis OFF (seconds)	Time ON (seconds)	Positiv Logic	Latched Output
1	AL1	NO-NON	1	0	0	NO-NON	NO-NON
2	AL2	NO-NON	5	0	0	NO-NON	NO-NON
3	AL3	NO-NON	30 <sup>(1)</sup>	0	0	NO	NO
4	FAULT	NO-NON	40	0	0	SI-YES-OUI	NO

(1) If the type of alarm set is "Parking-EN", this value becomes "60".

**SENSORS FOR VITAL GASES (Oxygen)**

Relay Number	ALARM	Silenceable	Hysteresis ON (seconds)	Hysteresis OFF (seconds)	Time ON (seconds)	Positiv Logic	Latched Output
1	AL1	NO-NON	5	0	0	NO-NON	NO-NON
2	AL↓	NO-NON	10	0	0	SI-YES-OUI	SI-YES-OUI
3	AL↑	NO-NON	10	0	0	SI-YES-OUI	SI-YES-OUI
4	FAULT	NO-NON	30	0	0	SI-YES-OUI	NO-NON

## Configuration Reminder Tables

 We recommend compiling these tables as a reminder of the configuration performed. We also recommend that you keep a copy in the control unit documentation.

Sensor configuration in the CE408								
Sensor Number [1÷16]	1	2	3	4	5	6	7	8
<b>MODEL. Sensor Model</b>								
<b>TAG (Label)</b>								
<b>Type</b> (Flammable, Toxic, Vitale, Refrigerant)								
<b>GAS detected</b> (Name or CAS or Formula)								
<b>UoM (Unit of Measure)</b> (% LFL, %vol, ppm, ppb or °C)								
<b>F.S. (Full Scale)</b> (Max 9.99 or 99.9 or 9999)								
<b>AL. (Alarm Type)</b> (Increasing, Decreasing, Oxygen, TLV, Parking-EN)								
<b>ZONE</b> (1÷4)								
<b>T.W.A.</b> (Only for PARKING-EN alarms)								
<b>THRESHOLD 1</b> (Alarm 1)								
<b>OUTPUT 1 (Relay number for AL1)</b>								
<b>SILENCEABLE</b> <sup>(3)</sup> (NO/YES)								
<b>TIME OF SILENCE</b> (from 0 to 300 Seconds)								
<b>HYSTERESIS ON</b> <sup>(4)</sup> (from 0 to 300 Seconds)								
<b>HYSTERESIS OFF</b> <sup>(5)</sup> (from 0 to 300 Seconds)								
<b>TIME ON</b> <sup>(6)</sup> (from 0 to 300 Seconds)								
<b>POSITIV LOGIC</b> (NO/YES)								
<b>LATCHED Output</b> <sup>(7)</sup> (NO/YES)								
<b>THRESHOLD 1</b> (Alarm 2)								
<b>OUTPUT 2 (Relay number for AL2)</b>								
<b>SILENCEABLE</b> <sup>(3)</sup> (NO/YES)								
<b>TIME OF SILENCE</b> (from 0 to 300 Seconds)								
<b>HYSTERESIS ON</b> <sup>(4)</sup> (from 0 to 300 Seconds)								
<b>HYSTERESIS OFF</b> <sup>(5)</sup> (from 0 to 300 Seconds)								
<b>TIME ON</b> <sup>(6)</sup> (from 0 to 300 Seconds)								
<b>POSITIV LOGIC</b> (NO/YES)								
<b>LATCHED Output</b> <sup>(7)</sup> (NO/YES)								
<b>THRESHOLD 3</b> (Alarm 3)								
<b>OUTPUT 3 (Relay number for AL3)</b>								
<b>SILENCEABLE</b> <sup>(3)</sup> (NO/YES)								
<b>TIME OF SILENCE</b> (from 0 to 300 Seconds)								
<b>HYSTERESIS ON</b> <sup>(4)</sup> (from 0 to 300 Seconds)								
<b>HYSTERESIS OFF</b> <sup>(5)</sup> (from 0 to 300 Seconds)								
<b>TIME ON</b> <sup>(6)</sup> (from 0 to 300 Seconds)								
<b>POSITIV LOGIC</b> (NO/YES)								
<b>LATCHED Output</b> <sup>(7)</sup> (NO/YES)								
<b>FAULT (Fault Relay Number)</b>								
<b>SILENCEABLE</b> <sup>(3)</sup> (NO/YES)								
<b>TIME OF SILENCE</b> (from 0 to 300 Seconds)								
<b>HYSTERESIS ON</b> <sup>(4)</sup> (from 0 to 300 Seconds)								
<b>HYSTERESIS OFF</b> <sup>(5)</sup> (from 0 to 300 Seconds)								
<b>TIME ON</b> <sup>(6)</sup> (from 0 to 300 Seconds)								
<b>POSITIV LOGIC</b> (NO/YES)								
<b>LATCHED Output</b> <sup>(7)</sup> (NO/YES)								



<b>Logic Input configuration in the Control Unit</b>	
<i>Input Number [1]</i>	<b>1</b>
<b>Active</b> (High <b>NO</b> or Low <b>NC</b> )	
<b>Output</b> (Relay Number)	
<b>SILENCEABLE</b> <sup>(3)</sup> (NO/YES)	
<b>TIME OF SILENCE</b> (from 0 to 300 Seconds)	
<b>HYSTERESIS ON</b> <sup>(4)</sup> (from 0 to 300 Seconds)	
<b>HYSTERESIS OFF</b> <sup>(5)</sup> (from 0 to 300 Seconds)	
<b>TIME ON</b> <sup>(6)</sup> (from 0 to 300 Seconds)	
<b>POSITIV LOGIC</b> (NO/YES)	
<b>LATCHED Output</b> <sup>(7)</sup> (NO/YES)	

**NOTE** <sup>(2)</sup> Only if the Expansion Board ES414 with 4 relay is installed.

**NOTE** <sup>(3)</sup> Normally leave NO. It is only used to temporarily silence the outputs connected to optical and / or acoustic indicators, for the silence time that can be set in the next line.

**NOTA** <sup>(4)</sup> To avoid false alarms, it is recommended to always set a value between 10 and 60 seconds. (typically 10÷20" for Optical/Acoustic alarms and 30÷60" for Gas Block Valves). In the event of a **Parking-EN** alarm, the minimum value is 60, but only for the relay linked to threshold 3.

**NOTA** <sup>(5)</sup> Normally leave ZERO. It is used only to keep devices activated, that for a limited time must remain in operation beyond the alarm. This function cannot be used in conjunction with the **Time ON** function and **Memory YES** cannot be selected.

**NOTA** <sup>(6)</sup> Normally leave ZERO. It is used only to deactivate devices that cannot remain in operation beyond a predetermined time. This function cannot be used in conjunction with the **Hysteresis OFF** function and **Latched YES** cannot be selected.

**NOTA** <sup>(7)</sup> The Output Latched is set **YES** only if **Hysteresis OFF** or **Time ON** are set to ZERO. Normally should be set to **YES** to prevent the resetting of an actuator (eg. Solenoid shut-off of the gas) without first verifying that the Control Unit is in alarm.

<b>CE408 Zone configuration</b>		
<i>Zone Number [1÷2]</i>	<b>1</b>	<b>4</b>
<b>LOGIC</b> (OR, AND, CORR.CON, CIRC.CON, PARKing-ITA)		
<b>OUTPUT 1 THRESHOLD 1</b> (1 <sup>st</sup> Relay Number for ALARM 1)		
<b>SILENCEABLE</b> <sup>(3)</sup> (NO/YES)		
<b>TIME OF SILENCE</b> (from 0 to 300 Seconds)		
<b>HYSTERESIS ON</b> <sup>(4)</sup> (from 0 to 300 Seconds)		
<b>HYSTERESIS OFF</b> <sup>(5)</sup> (from 0 to 300 Seconds)		
<b>TIME ON</b> <sup>(6)</sup> (from 0 to 300 Seconds)		
<b>POSITIV LOGIC</b> (NO/YES)		
<b>LATCHED Output</b> <sup>(7)</sup> (NO/YES)		
<b>OUTPUT 2 THRESHOLD 1</b> (2 <sup>nd</sup> Relay Number for ALARM 1)		
<b>TACITABILE</b> <sup>(3)</sup> (NO/SI)		
<b>SILENCEABLE</b> <sup>(3)</sup> (NO/YES)		
<b>TIME OF SILENCE</b> (from 0 to 300 Seconds)		
<b>HYSTERESIS ON</b> <sup>(4)</sup> (from 0 to 300 Seconds)		
<b>HYSTERESIS OFF</b> <sup>(5)</sup> (from 0 to 300 Seconds)		
<b>TIME ON</b> <sup>(6)</sup> (from 0 to 300 Seconds)		
<b>POSITIV LOGIC</b> (NO/YES)		
<b>LATCHED Output</b> <sup>(7)</sup> (NO/YES)		
<b>OUTPUT 1 THRESHOLD 2</b> (1 <sup>st</sup> Relay Number for ALARM 2)		
<b>SILENCEABLE</b> <sup>(3)</sup> (NO/YES)		
<b>TIME OF SILENCE</b> (from 0 to 300 Seconds)		
<b>HYSTERESIS ON</b> <sup>(4)</sup> (from 0 to 300 Seconds)		
<b>HYSTERESIS OFF</b> <sup>(5)</sup> (from 0 to 300 Seconds)		
<b>TIME ON</b> <sup>(6)</sup> (from 0 to 300 Seconds)		
<b>POSITIV LOGIC</b> (NO/YES)		
<b>LATCHED Output</b> <sup>(7)</sup> (NO/YES)		
<b>OUTPUT 2 THRESHOLD 2</b> (2 <sup>nd</sup> Relay Number for ALARM 2)		
<b>TACITABILE</b> <sup>(3)</sup> (NO/SI)		

<b>SILENCEABLE</b> <sup>(3)</sup> (NO/YES)		
<b>TIME OF SILENCE</b> (from 0 to 300 Seconds)		
<b>HYTEresis ON</b> <sup>(4)</sup> (from 0 to 300 Seconds)		
<b>HYTEresis OFF</b> <sup>(5)</sup> (from 0 to 300 Seconds)		
<b>TIME ON</b> <sup>(6)</sup> (from 0 to 300 Seconds)		
<b>POSITIV LOGIC</b> (NO/YES)		
<b>LATCHED Output</b> <sup>(7)</sup> (NO/YES)		
<b>OUTPUT 1 THRESHOLD 3</b> (1 <sup>st</sup> Relay Number for ALARM 3)		
<b>TACITABLE</b> <sup>(3)</sup> (NO/SI)		
<b>SILENCEABLE</b> <sup>(3)</sup> (NO/YES)		
<b>TIME OF SILENCE</b> (from 0 to 300 Seconds)		
<b>HYTEresis ON</b> <sup>(4)</sup> (from 0 to 300 Seconds)		
<b>HYTEresis OFF</b> <sup>(5)</sup> (from 0 to 300 Seconds)		
<b>TIME ON</b> <sup>(6)</sup> (from 0 to 300 Seconds)		
<b>POSITIV LOGIC</b> (NO/YES)		
<b>LATCHED Output</b> <sup>(7)</sup> (NO/YES)		
<b>OUTPUT 2 THRESHOLD 3</b> (2 <sup>nd</sup> Relay Number for ALARM 3)		
<b>TACITABLE</b> <sup>(3)</sup> (NO/SI)		
<b>SILENCEABLE</b> <sup>(3)</sup> (NO/YES)		
<b>TIME OF SILENCE</b> (from 0 to 300 Seconds)		
<b>HYTEresis ON</b> <sup>(4)</sup> (from 0 to 300 Seconds)		
<b>HYTEresis OFF</b> <sup>(5)</sup> (from 0 to 300 Seconds)		
<b>TIME ON</b> <sup>(6)</sup> (from 0 to 300 Seconds)		
<b>POSITIV LOGIC</b> (NO/YES)		
<b>LATCHED Output</b> <sup>(7)</sup> (NO/YES)		
<b>FAULT OUTPUT</b> (Common Fault Relay Number for all Sensors in the Zone)		
<b>SILENCEABLE</b> <sup>(3)</sup> (NO/YES)		
<b>TIME OF SILENCE</b> (from 0 to 300 Seconds)		
<b>HYTEresis ON</b> <sup>(4)</sup> (from 0 to 300 Seconds)		
<b>HYTEresis OFF</b> <sup>(5)</sup> (from 0 to 300 Seconds)		
<b>TIME ON</b> <sup>(6)</sup> (from 0 to 300 Seconds)		
<b>POSITIV LOGIC</b> (NO/YES)		
<b>LATCHED Output</b> <sup>(7)</sup> (NO/YES)		

**NOTE / NOTES:**

.....

.....

.....

.....



<b>Password LEVEL 1 (User)</b>	<b>Password LEVEL 2 (Installer or Maintenance tech.)</b>	<b>Control Unit Model</b>	<b>Control Unit Serial Number</b>
<input type="text"/>	<input type="text"/>	<b>CE408P</b>	<b>SN:</b> <input type="text"/>



**You may want to write and store the password (4 numbers) in a safe place. In case of loss of passwords, contact our assistance service.**



**The Serial Number is on the Test Label located inside, in the base of the Control Unit. The model and firmware version are visible at start-up or on display with **Settings** → **General** → **Info** menu.**

